

WESO GERNSBACH, Editor

# RADIO CRAFT

▼ AND POPULAR ELECTRONICS ▼



RADIO  
MOTOR-TORPEDOES  
SEE PAGE 400

ALEX  
CHOMBURG

APRIL

1944

25¢

CANADA 30¢

RADIO-ELECTRONICS IN ALL ITS PHASES

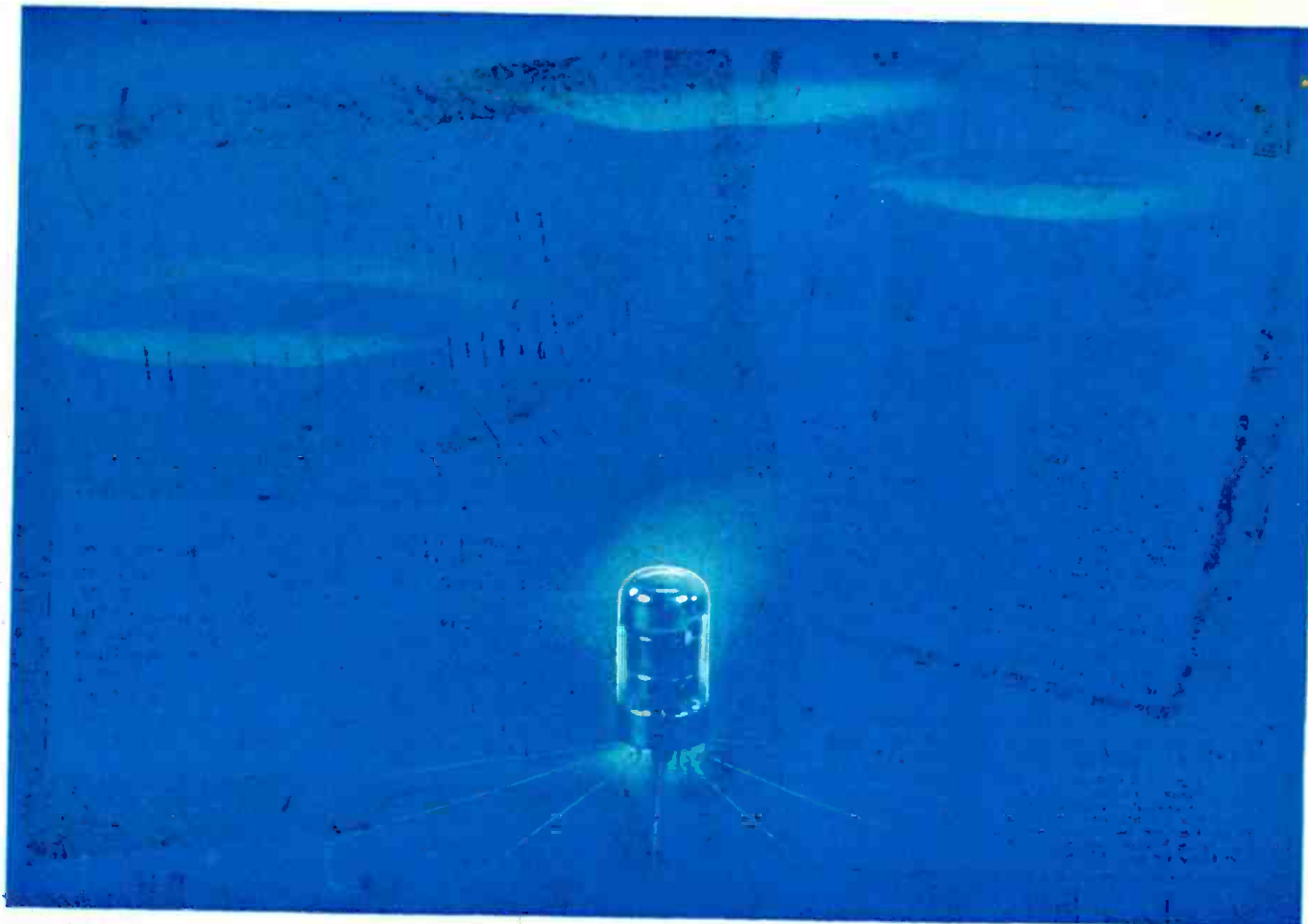

## **ART** AND SCIENCE...BOTH

Little wonder that tube making is often referred to as an *art*. For much of the work is by hand. To fashion these complex assemblies of filaments, grids, plates and wires; to position the parts within such close space limitations—parts, mind you, that often are so fragile, flimsy and elusive, *tweezers* are required to handle them—calls for a high degree of skill, a steady hand and an eye for accuracy. Art is right!

Yet, today, guiding every move of every N. U. production worker's hands is the "know how" of many scientists and engineers. Here are

chemists, physicists, metallurgists, and men high in the sciences of electronics and mechanics—all teamed up in a scientific tube development and production program recognized as a model throughout this industry.

It takes a lot of *both* science and art to make the advanced-design, high performance N. U. tubes now being produced for combat service. Today they are being battle-tested for the greatly expanded post-war needs of service engineers. *Count on National Union.*

**NATIONAL UNION RADIO CORPORATION, NEWARK, N. J.**  
Factories: Newark and Maplewood, N. J., Lansdale and Robesonia, Pa.



# **NATIONAL UNION**

## **RADIO AND ELECTRONIC TUBES**

Transmitting, Cathode Ray, Receiving, Special Purpose Tubes • Condensers • Volume Controls • Photo Electric Cells • Panel Lamps • Flashlight Bulbs

**Men NOW in Radio  
who Don't Think  
they know it ALL  
Read This**

If you're a Radio Serviceman you want to keep up with latest Radio developments, be ready to service the FM receivers, Television sets, and understand Electronic devices. You DON'T want to lose out because you lack TECHNICAL knowledge... If you're an operator you don't want to be baffled by new Radio circuits, equipment. You want the EXTRA knowledge that wins promotions, extra pay. Read my message below—then MAIL COUPON!

**If You're NOT  
Working in Radio Now  
Read This**

You should begin cashing in on your interest in Radio QUICKLY—ACT NOW! The Radio repair business, a busy field because no new home and auto Radios are being made, offers more opportunities than ever to make \$50 a week in full time jobs or your own business—or to make \$5 to \$10 a week EXTRA fixing Radios in spare time. Practically all branches of Radio need Technicians or Operators or both. Find out how I train you at home—how I give you practical experience. Read my message below—then MAIL COUPON.



J. E. SMITH, President  
National Radio Institute  
30th Year of Training Men for Success in Radio

**FREE RADIO LESSON**

I will send you a FREE Lesson, "Getting Acquainted with Receiver Servicing," to show you how practical it is to train at home. It's a valuable lesson. Study it—keep it—USE it—without obligation! Tells how "Superhet" Circuits work, gives hints on Receiver Servicing, Locating Defects, Loudspeaker Repair, Gang Tuning Condenser, etc. 31 Illustrations. Mail Coupon NOW for your FREE copy!

**Make Me Prove I Can Train You at Home  
to Be a RADIO TECHNICIAN or OPERATOR**

**YOU BUILD THESE AND MANY  
OTHER RADIO CIRCUITS  
WITH KITS I SUPPLY**

By the time you've conducted 60 sets of Experiments with Radio Parts I supply — have made hundreds of measurements and adjustments — you'll have had valuable PRACTICAL experience.

You build this SUPER-HETERODYNE CIRCUIT containing a preselector, oscillator-mixer-first detector, I.F. stage, diode detector-a.v.c. stage and audio stage. It will bring in local and distant stations. Get the thrill of learning at home evenings in spare time while you put the set through fascinating tests!

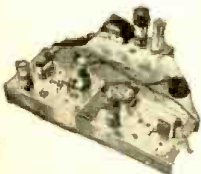

You build this MEASURING INSTRUMENT yourself early in the Course, useful for practical Radio work on neighborhood Radios to pick up EXTRA spare time money. It is a vacuum tube multimeter, measures A.C., D.C. and R.F. volts, D.C. currents, resistance, receiver output.

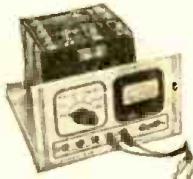

Building this A.M. SIGNAL GENERATOR will give you valuable experience. Provides amplitude-modulated signals for test and experimental purposes.

Whether you're a beginner, or already in Radio—whether you want your own Radio business or a good Radio job—mail the Coupon for a FREE Lesson from my Radio Course. I want you to see for yourself how clear my Course is—see how it's planned to help you become a successful Radio Technician or Operator. And with this sample lesson I'll send my 64-page Illustrated book, "Win Rich Rewards in Radio." It describes the many fascinating jobs Radio offers; explains my unique training method. My method has helped many men already in Radio. Edward M. Schimke, 425 N. 21st St., Irvington, N. J., wrote: "I found I was losing both time and money in my Radio business; then I applied the knowledge gained from your Course and my business grew from a small room to an up-to-date store." It has helped hundreds of beginners, too. Here is what James E. Ryan, 119 Pebble Court, Fall River, Mass., writes: "I was working in a garage when I enrolled with N.R.I. I am now Radio Service Manager of 4 stores." My FREE book contains more than 100 letters like these from men I trained. They show that N.R.I. gives real help!

**More Radio Technicians and Operators  
Now Make \$50 a Week Than Ever Before**

There's a big shortage of capable Radio Technicians and Operators because so many have joined the Army and Navy. Fixing Radios pays better now than for years. With new Radios out of production, fixing old sets, which were formerly traded in, adds greatly to the normal number of servicing jobs.

**Many Beginners Soon Make \$5, \$10  
a Week EXTRA in Spare Time**

The moment you enroll for my Course I start sending you EXTRA MONEY JOB SHEETS that show how to earn EXTRA money fixing Radios. Many make \$5, \$10 a week EXTRA in spare time while still learning. I

**Extra Pay in Army, Navy, Too**

Men likely to go into military service, soldiers, sailors, marines, should mail the Coupon now! Learning Radio helps get extra rank, extra prestige, more interesting duties, HIGHER PAY. Also prepares for good Radio jobs after service ends. Over 1700 Service men now enrolled.



send you SIX big kits of real Radio parts. You LEARN Radio fundamentals from my lessons—PRACTICE what you learn by building typical circuits like those illustrated on this page—PROVE what you learn by interesting tests on the circuits you build.

**Be Ready to Cash in on Good Pay Jobs  
Coming in Television, Electronics**

Broadcasting Stations, Aviation and Police Radio, and other Radio branches are scrambling for Operators and Technicians. Radio Manufacturers, now working on Government orders for Radio equipment, employ trained men. The Government, too, needs competent Civilian and enlisted Radio men and women. And, think of the NEW jobs that Television, Electronics and other Radio developments will open after the war.

**Mail Coupon for Free Lesson and Book**

The opportunity the war has given beginners to get started in Radio may never be repeated. So take the first step at once. Get my FREE Lesson and 64-page, illustrated book. No obligation—no salesman will call. Just mail coupon in an envelope or paste it on a penny postal.—J. E. SMITH, President, Dept. 4DX, National Radio Institute, Washington 9, D. C.

**GOOD FOR BOTH 64 PAGE BOOK FREE  
SAMPLE LESSON FREE**

J. E. SMITH, President, Dept. 4DX  
National Radio Institute  
Washington 9, D. C.

Dear Mr. Smith: Mail me FREE without obligation, your Sample Lesson and 64-page book, "Win Rich Rewards in Radio," which tells about Radio's spare time and full time opportunities and tells how you train men at home to be Radio Technicians. (No salesman will call.)

I AM doing Radio Work.  I am NOT doing Radio Work.

Name ..... Age.....

Address .....

City ..... State ..... 4FR





"RADIO'S GREATEST MAGAZINE"

HUGO GERNSBACK, *Editor-in-Chief*  
 FRED SHUNAMAN, *Associate Editor*  
 G. ALIQUO, *Circulation Manager*

### IN THE NEXT ISSUE

Giant Radio Motor Torpedo  
 Replacements and Ohm's Law  
 More on Audio Distortion  
 Dynamic Circuit Checking  
 Low Voltage Radio Receiver  
 An Electron Microvoltmeter

Published by Radercraft Publications, Inc.  
 Publication Office: 29 Worthington Street,  
 Springfield 3, Mass.  
 Editorial and Advertising Offices: 25 West  
 Broadway, New York 7, N. Y.  
 Chicago Advertising Office: Radio-Craft, 520  
 North Michigan Avenue, Chicago 11, Ill.

RADIO-CRAFT is published monthly, on the  
 25th of the month preceding that of date; sub-  
 scription price is \$2.50 per year in U. S. (In  
 foreign countries, 75c additional per year to  
 cover postage; Canada, 50c additional.) Spe-  
 cial rates for members of the Armed forces  
 in U. S. or those addressed by A.P.O. or  
 F.P.O. mail, \$2.00. Entered at the post office  
 at Springfield as second-class matter under the  
 Act of March 3, 1879. All communications  
 about subscriptions should be addressed to:  
 Circulation Manager, Radio-Craft, 29 Worthing-  
 ington St., Springfield 3, Mass.

Notice of CHANGE of ADDRESS should  
 reach us at least one month in advance. When  
 ordering a change, please furnish an address  
 stencil impression from a recent wrapper if  
 you can. Address changes cannot be made  
 without the old address as well as the new.

#### Foreign Agents

London—Atlas Publishing and Distributing  
 Co., Ltd., 18 Bride Lane, Fleet St., London,  
 E.C. 4.  
 Melbourne—McGill's Agency, 179 Elizabeth  
 St., Australia.

Text and illustrations of this magazine are  
 copyright and must not be reproduced without  
 permission of the copyright owners.  
 Copyright, 1944, Radercraft Publications, Inc.

## Contents

April, 1944

Volume XV, No. 7

Editorial: The Nazis Are First .....	by Hugo Gernsback	393
Radio-Electronics Monthly Review .....		394
Sally, the Service Maid .....	by Nate Silverman	413

### ELECTRONICS

Raysonde—Sky Radio .....	by Vernon D. Hauck	396
Radium-Radio Receiver .....	by Mohammed Ulysses Fips	398
Industrial Electronics, Part II .....	by Raymond F. Yates	402
Electron Age Coming .....	by E. M. Roberts	404
The Enormous Electron .....		405
A Course in Practical Electronics, Lesson I .....	by Fred Shunaman	406
Electron Tubes, from Brass-Base to Loctal .....		414

### WAR-TIME RADIO

Radio Motor Torpedoes .....	by Hugo Gernsback	400
Two-tube FM Receiver .....	by Dean S. Edmonds	410
Future Radio Rockets .....		428

### RADIO TRAINING

Electronic Diagrams .....	by Carl H. Winter	408
Audio Distortion .....	by Ted Powell	409
Electronic Circuit Checks, Part III .....	by R. E. Altomare	411

### SERVICING

Calibrating Generators .....	by Jack King	412
A Useful Speaker Tester .....	by Archie V. Carpenter	416
Add a Tone Control .....	by Fred U. Dillion	416
A Serviceman to His Son .....	by Eugene M. Conklin	426

### CONSTRUCTION

"Woodyard" Winder .....	by A. Heisler	430
-------------------------	---------------	-----

### DEPARTMENTS

World-Wide Station List .....	Edited by Elmer R. Fuller	415
New Radio-Electronic Devices .....		418
The Question Box .....		420
Radio-Electronic Circuits .....		422
Try This One! .....		424
Technotes .....		443
The Mail Bag .....		444
Book Reviews .....		447

### ON THE COVER

Gigantic super-torpedoes which would compare in size to small submarines, directed to pursue a direct and deadly course to their helpless target, are envisioned on our cover this month. A pilot-observer would direct one or more of these super-torpedoes by electronic means, making them change course, turn, or even stop and lurk for enemy ships to come within their zone of action.



# A Gift from Jerry!

The Hallicrafters built SCR-299 was moving along a North African road amidst a hail of bombs and shells. Concussions made the earth seem to heave and swell. The radio operator listening intently to a message coming through thinks "Jerry is giving us all he's got... will all the message come through or will part of it be lost?" Then came a mighty crash, the closest one yet. "Jerry is sure dishing it out... but the SCR-299 can take it!" Radio operators testify that the SCR-299 has operated through the most violent battle conditions. Rough roads, shock of concussions, heat and sand storms, twenty-four hour operation, and Jerry himself could not stop the message from "coming through!"

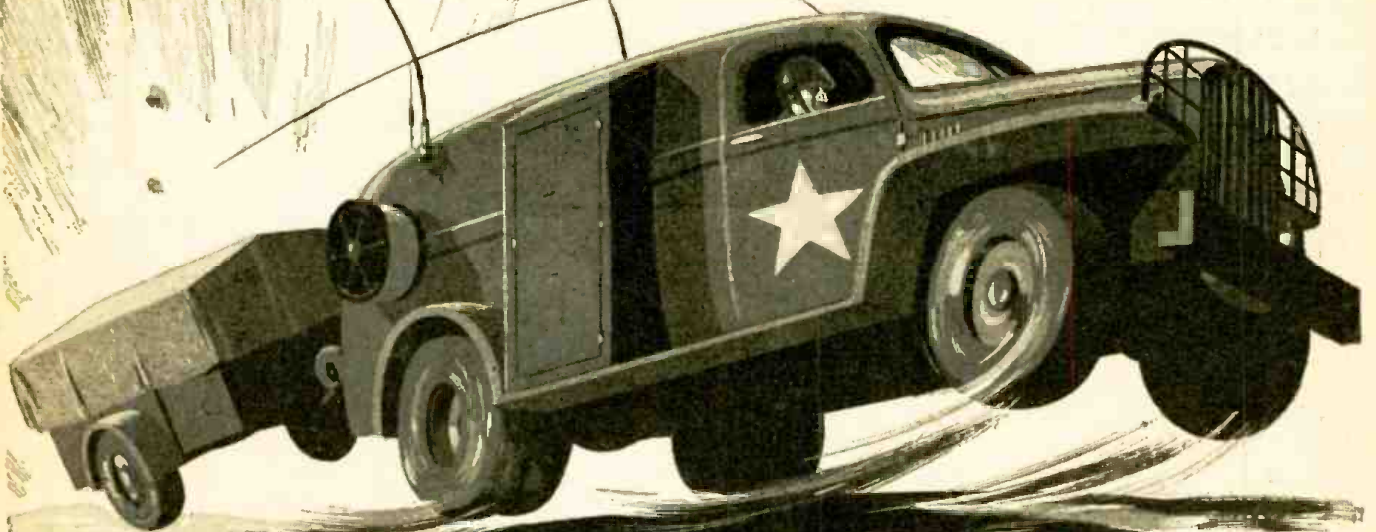

BUY MORE BONDS!



## hallicrafters RADIO

THE HALLICRAFTERS CO., MANUFACTURERS OF RADIO AND ELECTRONIC EQUIPMENT, CHICAGO 16, U. S. A.  
RADIO-CRAFT for APRIL, 1944

# A Tribute



A TRIBUTE to the members of the Signal Corps, United States Army, for their great achievements in the field of military communications. On every front, from the development laboratory to the most remote outpost, they are doing their job superbly well.

Hallicrafters employees are proud of the part they are privileged to take in the design and production of radio equipment for the Signal Corps.

**hallicrafters RADIO**



BUY MORE BONDS!

THE HALLICRAFTERS CO., MANUFACTURERS OF RADIO AND ELECTRONIC EQUIPMENT, CHICAGO 16, U. S. A.

# HERE IS YOUR SUCCESS CHANCE

BE A

# RADIO-ELECTRONIC TECHNICIAN!

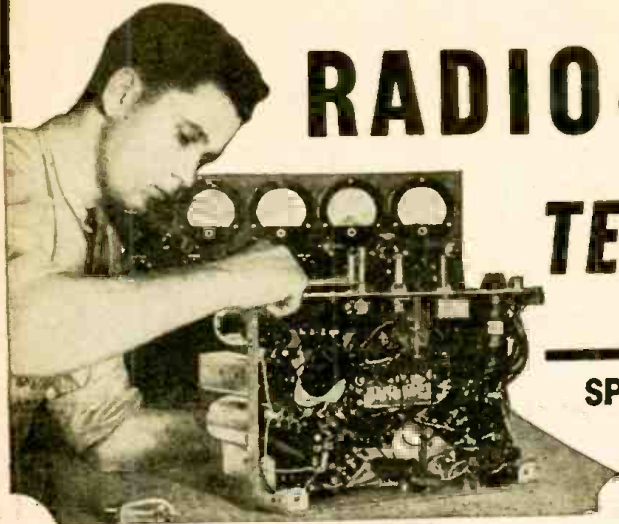

**SPRAYBERRY TRAINS YOU  
QUICKLY FOR WAR  
AND PEACETIME WORK**

**IF YOU REMAIN A  
CIVILIAN OR ENTER  
MILITARY SERVICE . . .  
Radio Training Will  
Enhance Your Future!  
• READ THESE LETTERS •**

**One Job Nets About \$26.00**  
"Since last week I fixed 7 radios, all good-paying jobs and right now I am working on an amplifier system. This job alone will net me about \$26.00. As long as my work keeps coming in this way, I have only one word to say and that is "Thanks to my Sprayberry training" and I am not afraid to boast about it."—ADRIEN BENJAMIN, North Grosvenordale, Conn.

**Sprayberry Graduate Wins  
Out in Army Test**  
"Since I completed your elegant Course in Radio I have been drafted into the Army and put into the Signal Corps. I had to compete to get the job I now hold and as a result of my training with you, I made the best grade and got the job. The point I am driving at is if it hadn't been for your thorough course in Radio I would probably be peeling potatoes now. I recommend your training to all because it is written in language that the average layman can understand."—ARCH PLUMMER, JR., Fort Meade, Md.

**Student Makes \$15.00 to \$20.00  
A Week in Spare Time**  
"After starting your Course I began doing minor radio service jobs and I want to say that I have been flooded with work. So much so that I have had to neglect my lessons. I want to say your training has done a great deal for me. I am making \$15.00 to \$20.00 a week in spare time. Even so, I'm going to go back to my studies and finish the Course."—S A N F O R D J. CHILCOINE, Whitley, Ontario, Canada.

**You Do Practice-Giving Experiments  
with Real Equipment**

The offer I make you here is the opportunity of a lifetime. It's your big chance to get ready for a wonderful future in the swiftly expanding field of Radio-Electronics INCLUDING Radio, Television, Frequency Modulation, and Industrial Electronics. Be wise! NOW is the time to start. No previous experience is necessary. The Sprayberry course is short, intensive, and interesting. It starts right at the beginning of Radio. You can't get lost. It gets the various subjects across in such a clear, simple way that you understand and remember.

**You Get a Dual-Purpose Radio Set**

**FULL RADIO SET**

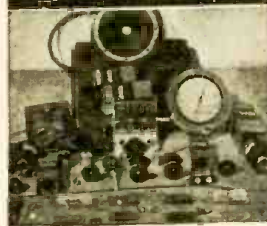

I supply you with Radio Parts which you use to gain pre-experience in Repair work. These same Parts are used for testing and for Signal Tracing, etc. I make it easy for you to learn Radio Set Repair and Installation Work . . . by practical, proved, time tested methods. I teach you how to install and repair Electronic Equipment. Your success is my full responsibility.

**Prepares You for a Business of Your Own . . . or  
Good Radio Jobs**

My training will give you the broad fundamental principles so necessary as a background no matter what branch of Radio you wish to specialize in. Soon you'll be qualified for a good paying job in one of the nation's Radio plants doing war work OR a business of your own. If you enter the Army, Navy, or Marines, my training will help you win higher rating and better pay. Let me prove what Sprayberry training can do for you.

**EASY TO START . . .**

Remember it is not necessary for a Sprayberry student to have any previous experience in the field of Radio. You can master the Course in your spare time. It will not interfere in any way with your present duties.

Along with your Training, you will receive my famous Business Builders which can bring you in a nice profit shortly after you begin my course.

**DON'T  
PUT  
IT OFF!**

Get the facts about my training—now! Take the first important step toward the money-making future of your dreams. All features are fully explained in my big, illustrated free book. Write for it at once.

**GET FREE BOOK**

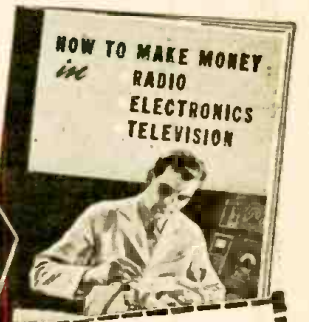

**SPRAYBERRY ACADEMY OF RADIO**  
F. L. Sprayberry, Pres.  
Box 500 TD  
Pueblo, Colorado.  
Please rush my FREE copy of "HOW TO MAKE MONEY IN RADIO, ELECTRONICS and TELEVISION."

Name . . . . . Age . . . . .  
Address . . . . .  
City . . . . . State . . . . .  
Tear off this coupon, mail in envelope or paste on penny postcard.

**NOW! BECOME A MONEY-MAKING RADIO SPECIALIST**

# SPRAGUE TRADING POST



## A FREE Buy-Exchange-Sell Service for Radio Men

### IMPORTANT NOTICE!

We discourage offers to buy or sell anything beyond the O.P.A. ceiling prices, and will not knowingly accept such ads for the Sprague Trading Post. Buyers and sellers please cooperate by reporting infringements.

**WANTED—R.C.P. No. 802** or similar tester. Cash. J. W. Thompson, P. O. Box 167, Boston 18, Mass.

**WANTED—Late model new** or used tube tester. Dick Wallace, Box 85, Donnelly, Idaho.

**WANTED—Professional recording** eqpt. & blank recording discs. Describe fully. George Toney, Box 125, New Kensington, Pa.

**FOR SALE—Confidence Automatic** Model B tube tester with chart and modernizing adapters. \$20. Shirley Ince, Route 1, Hiro, Texas.

**WANTED—RCA voltohmmyst, Jr.,** working or otherwise; also Rider's manuals 8 to 13 incl. Will buy or have 12" Utah PM speaker; a-c voltmeter and ma. meter to trade. McCullough Radio Service, 3328 N. Kenwood Ave., Indianapolis 8, Ind.

**EQPT. FOR SALE—AmerTran** audio transformers, deluxe 1st stage, input No. 151, output No. 678, intermediate No. 710, equalizer No. 389. Also AmerTran power transformers, PF250 (450 V, 200 m.a.), also type H-67; Choke coils, three No. 854, No. 709. No. 557; AmerTran resistance type No. 400. Robert Lee, 337 Cuyler Ave., Trenton 9, N. J.

**WANTED FOR CASH—Good signal** generator & tube checker. Sgt. Roy Addis, 12th H.B. Proc. Hq., Lincoln A.A.B., Lincoln, Nebr.

**WANTED—Set of Rider's manuals.** Cash or will swap a Paterson PR10 as part payment. Kenneth M. Rude, 751 W. 101 St., Los Angeles, Calif.

**NEEDED URGENTLY—Tube checker** and multimeter. Describe fully. Leroy P. Sanders, 1725 Oregon St., Berkeley 3, Calif.

**WANTED—Late model port. tube** tester having up to 117-V and neon short test; also good d-c voltmeter 0-500 volts and a-c voltmeter 3". Cash. Walt's Radio Service, 1801 Illinois Ave., Lansing 6, Mich.

**FOR SALE—Triplet all-wave radio** servicer (comb. signal generator and V-O-M) A-1 condition. \$25. Gene Burton, Shop Springs, Tenn.

**FOR SALE OR SWAP—Limited supply** W.E. 205-D & 264-C sound tubes, new. Need a-c signal generator. W. C. Brannon, 1214 Randolph, El Paso, Texas.

**URGENTLY NEEDED—Superior** No. 1230 signal generator, also good capacitor analyzer. Cash. W. M. Finley, Jr., Norfolk, Ark.

**WANTED—15 ohm magnetic induction** hi-fidelity lateral cutting head for direct acetate recordings. Cash. E. A. Wenzel, Saddle River Rd., Monsey, N. Y.

**WANTED FOR CASH—Rider channel-**lyst; Hickok signal generator No. 188X, good oscilloscope and condenser checker. Jewel A. Larson, 123 So. Washington Ave., Albert Lea, Minn.

**WANTED FOR CASH—Hallcrafters** Sky Buddy or Sky Champion or Echophone EC-1 in A-1 condition. Pvt. Robert C. Lynch, Co. A-655—T.D.T. Bn., Camp Hood, Texas.

**WANTED—A good sig. generator,** new or used. Cash. James Billington, General Delivery, Jewette City, Conn.

**WANTED FOR CASH—Radio City** No. 309P tube tester, or Supreme No. 589P portable ditto in good A-1 condition. Otho J. Blue, 515 W. Wright St., Pensacola, Fla.

**FOR SALE—Second hand tubes:** 35Z5GT; 12SK7; 12SQ7; 50L6GT; 25Z6GT; 9001; and 9002. Want V-O-M or tube tester. Bill Wrocklage, 381 Main St., Hackensack, N. J.

**WANTED—Communication receiver,** Hallicrafter or equivalent. Will trade Clough-Brengle model O.M.A. R.F. & A.F. with sweep motor for scope, paying difference in cash. Wanted for a shut-in. T. L. Liles, 1600 Center St., Owensboro, Ky.

**WANTED—Rider's manuals vols. 6** to 12 incl. in good condition, also one modern tube tester. Harry Dufore, Archer, Fla.

**TUBES FOR SALE—Will sell one or** all of following at 65% off list. New, in original cartons, various std. makes: 1-2B7; 4-2A7; 4-2A3; 1-6A6G; 2-A6; 9-6A6; 2-6AB5; 9-6AC5; 4-6B7; 2-6BRG; 2-6E7; 3-607; 4-31; 3-01A; 5-6F7; 5-6L6; 6-6N6G; 3-6V7G; 2-12A5; 1-12A7; 3-25A6G; 1-36; 4-38; 7-39/44; 4-50; 5-79; 3-89; 1-53; 2-81. Crawford Radio Service, 429 Colorado Ave., Grand Junction, Colo.

**WANTED—Supreme multimeter No.** 543M or Precision series 832A or No. 834. Must be in A-1 condition. Wm. Johnson, 1410 Harrison Ave., R. Butte, Montana.

**FOR SALE—Several used amplifiers,** 10 to 40 watts; 3 new and used call systems 10-station, some used V-O-M. Need recorder, phono motors, used test eqpt., meters, etc. T. J. Davie, 332 No. San Antonio St., San Mateo, Calif.

**WANTED FOR CASH—Two 35Z5GT** tubes. Jack Petrik, 2520 Country Club, Omaha, Nebr.

**WANTED—Good modern tube check-**er. Describe fully. F. Williams, Box 23, Buena, Wash.

**WANTED—Hallicrafters Skytraveler** or equivalent. Condition unimportant. Pvt. Monroe Reese, Training Group 58, Class 149, Keesler Field, Miss.

**WANTED—P.A. system—Bogen.** Webster or S-C preferred, with 2 speakers (Jensen preferred) to match; also a crystal or unidirectional mike. Not less than 20 watts output. F. G. Newell, 45 Chestnut St., Marlboro, Mass.

**FOR SALE—RCA-Rider channel-**lyst; Philco 077 signal generator; Dayrad No. 50 output meter; Pioneer generator, 300 volt, 100 mill. Want for cash: Hickok 510-X and 210-X and 1LA6 or 1LC6; 117Z6; 117P7; 35A6; 12SA7; 12SK7; 1H5; 80; 35L6; and 35Z3 tubes. C. F. Carrick, 420 Sherman Ave., Couer D'Alene, Idaho.

**TUBES FOR SALE as follows:** 6-6D7; 3-34; 3-483; 1-485; 2-48; 2-49; 4-6B4; 1-6B7; 1-6B5; 1-6E7; 3-6E6; 5-6P7; 3-6G6; 2-6B8; 3-6W7; 4-99; 3-6Z7; 2-6A6; 1-91; 2-50; 2-10; 4-12Z5; 3-1B4; 1-1C6; 3-1A6; 3-1F4; 2-12A5; 2-25A6; 2-31; 2-32; 4-12A7; 3-1A4; 2-2A7; 2-22; 1-1H6; 1-1A6. Harry's Auto Parts, 128-2nd St. N.W., Barberton, Ohio.

**FOR SALE—Brand new 35-watt am-**plifiers, Western Sound make. 2 mike inputs, one phono. Want pick-ups and phono motors. B & B Sound Systems, Two Rivers, Wis.

**FOR SALE—Rider's manuals nos. 2** to 10 incl. \$60. Want Vol. 12 and any std. make condenser tester. H. L. Mills, 8006 Truxton Ave., Los Angeles 43, Calif.

**FOR SALE OR TRADE—One Green** flyer phono motor and 10" turn table. \$12 cash or will trade for recording motor and turn table. Also need 31 type tubes. Jas. F. Morgan, 811 Park Ave., Anderson, Ind.

**WANTED—All wave signal gener-**ator; tube tester not more than 3 yrs. old. Must be A-1 with instructions. Quince Mitchell, Brant Lake, N. Y.

**WANTED—Triplet V-O-M No.** 1600E. Cash. Ray Blaney, 202 Troy St., Canton, Pa.

### "NOT A FAILURE IN A MILLION"

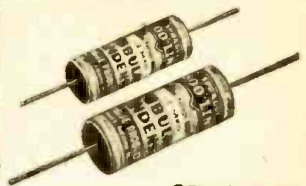

### SPRAGUE "TC" TUBULARS

When there's a by-pass capacitor job to do, do it with famous Sprague TC Tubulars—and forget it. They will not let you down! We'll appreciate it if you ask for them by name.

**WANTED—Triplet No. 1175B** tester (also known as the NRI set analyzer). Paul H. Aehterberg, Burlington Hotel, Broken Bow, Nebr.

**URGENTLY NEEDED—V-O-M in** good condition. Describe fully. Harold Denny, Portersville Road, Washington, Ind.

**FOR SALE—Rack and panel 500-**watt transmitter; two 60" steel W.E. racks on rollers; r-f and phone in separate racks. Misc. xmitting tubes; coils, hundreds of parts; condensers and transformers; extra chassis with plate and grid condensers to handle kw together with 450TL Eimac tube; vibroplex; type 22D Turner dynamic mike with 15" cable. What do you offer? E. S. Hillery, 23 East 11th St., Bayonne, N. J.

**TUBES FOR SALE—50L6 and** 35L6's. Write for details. Randall McDonald, 506 N. Ward St., Benton, Ill.

**FOR SALE—Two old meters and** several de luxe A-F transformers. Write for details. Wallace M. Kennard, R.D. 2, Wilmington, Del.

**FOR SALE OR TRADE—Hickok** 4780 capacity tester, brand new. Will sell or trade for 12-volt tubes or new table radio. Miller Electric Service, Ellenville, N. Y.

## YOUR OWN AD RUN FREE!

Send us your Sprague Trading Post advertisement today. We'll be glad to run it free as part of our special wartime advertising service to the radio profession. WRITE CAREFULLY OR PRINT. Hold it to 50 words or less. "Equipment for Sale" and "Wanted" advertisements of an emergency nature will receive first attention. Different Trading Post ads appear regularly in RADIO RETAILING-TODAY, RADIO SERVICE-DEALER, SERVICE, RADIO NEWS and RADIO-CRAFT. Please do not specify any particular magazine for your ad. We'll run it in the first available issue that is going to press. Sprague, of course, reserves the right to reject ads which, in our opinion, do not fit in with the spirit of this service.

SPRAGUE PRODUCTS CO., DEPT. RC-44 North Adams, Mass.

# SPRAGUE CONDENSERS KOOLOHM RESISTORS



Obviously, Sprague cannot assume any responsibility, or guarantee goods, services, etc., which might be exchanged through the above advertisements



"THE BOSS IS POUTING BECAUSE  
HOGARTH WON'T TRADE  
HIS **ECHOPHONE EC-1** FOR  
ANYTHING WHATSOEVER"

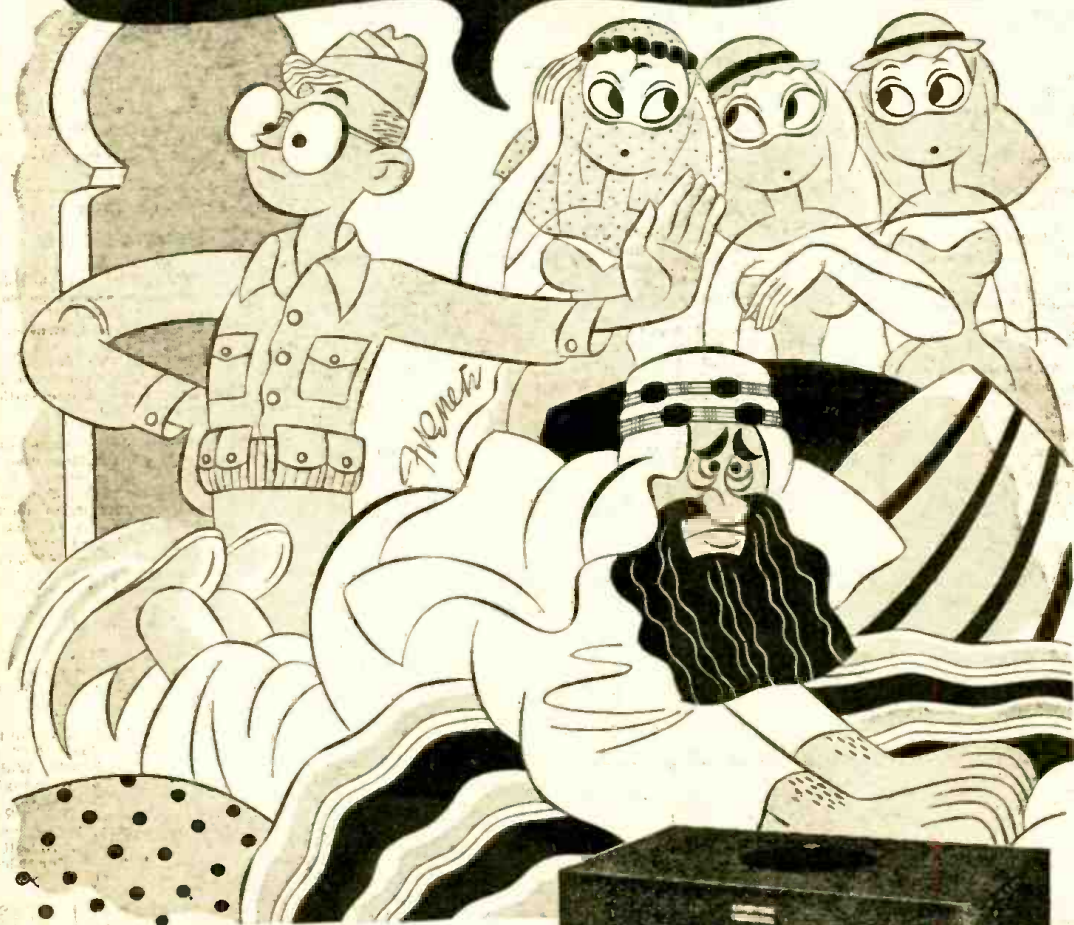

**Echophone Model EC-1**

(Illustrated) a compact communications receiver with every necessary feature for good reception. Covers from 550 kc. to 30 mc. on three bands. Electrical band-spread on all bands. Beat frequency oscillator. Six tubes. Self-contained speaker. Operates on 115-125 volts AC or DC.



# ALL EYES ON MT. CARMEL!



**On Guard!** Symbol of watchfulness at the Meissner plant is this alert, keen-eyed sentinel. All prying eyes are kept at a safe distance, but there's no hiding the fact that great things are in the making here.

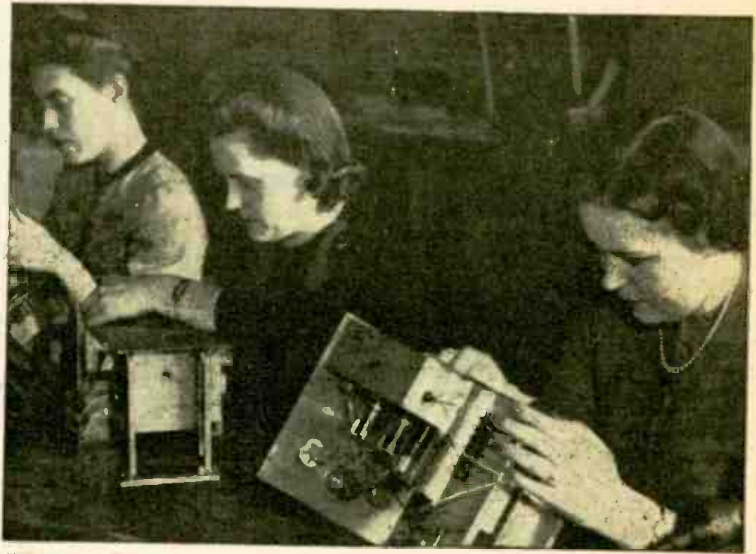

What New Marvels these girls have seen! They're on the inspecting line at the Meissner plant in Mt. Carmel, Illinois, source of numerous major war departments in the electronics field.



**Testing:** These two men pack a world of electronics knowledge behind youthful faces. They literally "grew up" in the business — thanks to the fact that there are more electronics technicians per thousand population in Mt. Carmel than in any other city.



Meissner's "Precision-El": Long experience, plus "home town" enthusiasm for the job, have so astonished visitors that they refer to Meissner's personnel as "precision-el." And Meissner's "precision-built" products prove the case!

## ILLINOIS ELECTRONICS CENTER HUMS WITH FUTURE PROMISE

Nearly everywhere you look these days — in America's newspapers or magazines — you're apt to find a glowing reference to Mt. Carmel, or to the Meissner Manufacturing Company. That's because the little Illinois city and its largest industry are both in the forefront of important postwar thinking. Hub of much of this activity is the Meissner laboratory, which occupies an entire floor of the main office building. There are so many closely guarded secrets here, in fact, that no photographer dares set tripod inside!

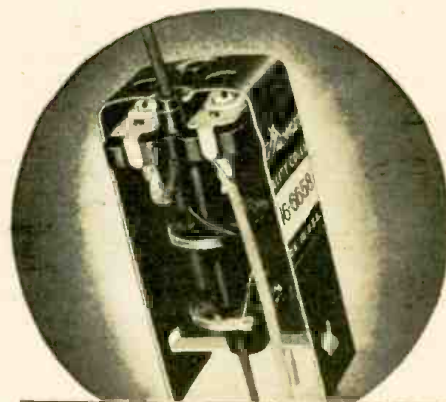

### Wide Range, High Gain

Here are the famous "big four" benefits of Meissner "Plastic" I.F. Transformers: (1) wide range; (2) high gain; (3) remarkable stability; (4) double tuning. They're particularly suitable for use in small receivers, where space is at a premium, yet superior performance is required. Only  $1\frac{1}{4}$ " square x  $2\frac{1}{4}$ ", yet are not affected by temperature, humidity or vibration. Complete with specially served Litz wire and one-piece molded plastic coil-form and trimmer base. Now ready for delivery, but order promptly

# MEISSNER

MANUFACTURING COMPANY • MT. CARMEL, ILL.

ADVANCED ELECTRONIC RESEARCH AND MANUFACTURE

RADIO-CRAFT for APRIL, 1944

# The Nazis Are First

... The Germans during this war get there first because they appropriate ideas and inventions made long ago by the Allies ...

HUGO GERNSBACK

**T**HIS does not make a pleasant-reading article, because unfortunately, truth is forever unpleasant, particularly when it strikes home.

Let us look at the record and see what we find. Since the beginning of World War II, Nazi technicians have uniformly excelled the democratic countries in practically all of their major war devices. This includes the entire range, beginning with submarines, airplanes, artillery, radio devices and other weapons.

It would seem that the Nazis have always had better co-ordination of their technical bureaus than is the case with the Allies. While it is true that the Germans had a seven-year jump on the rest of the world, it is equally true that all their surprise weapons and war devices, with their superiority in war machines are not new. Indeed, they are quite old, but the Germans have shown courage and imagination in exploiting these old ideas and then springing them as surprises on the Allies.

There comes to mind devices such as the Nazi magnetic mine. This idea is as old as the hills, and in one of my publications over 20 years ago, we featured it. Nevertheless, the Allies were caught flatfooted and many of our ships with precious war cargoes were sunk before the Allied degaussing device stopped the mischief. Next, their "magnetic torpedo"—which if it misses the mark can be drawn to it by the magnetic effect of the ship—is equally ancient, but again the Nazis used it first.

In aviation America was woefully behind the Germans even as late as Pearl Harbor. Our plane armament was totally inadequate, and America—the land of the airplane—really did not get anywhere until the middle of 1942. We were at least five years behind the Germans in this respect.

In such a supposed prosaic war arm as artillery, Mr. Hanson Baldwin, military expert of the *New York Times*, late in February of this year states:

"The German 88-mm. and 170-mm. are two of the best guns of the war. German heavy artillery was far ahead of ours until forward-looking officers in the Army insisted on pushing this development about a year ago; in Italy the Germans probably still have an edge in heavy artillery. The use of their very light 'Nebelwerfer,' or

six-barreled rocket gun, in the Italian mountain warfare has proved ideal; it can be transported to mountain positions because of its lightness, with more ease than a (our) 75-mm. or 105-mm., and it lays down a terrific barrage—though with less precision accuracy. We have nothing exactly to match it in Italy."

I could go on giving many more examples on various war devices, but from here on I will restrict my remarks to radio only.

When last I visited Germany in 1932, I wrote a complete report on German Radio. At that time Germany was at least five years behind the United States, as far as radio development was concerned, as I stated in *RADIO-CRAFT* at the time. On the advent of Hitler, the situation changed rapidly and every possible radio device that could be mustered for war purposes was scanned carefully and thoroughly by the Nazis. The result is that today Germany is unquestionably first when it comes to radio war applications. It is true that such items as radio sets and transmitters have been frozen and are perhaps a few years behind American receivers and transmitters, but, nevertheless, in the opinion of all who have seen and investigated the German apparatus, even the most rabid critic had to admit that the Nazi receivers and transmitters were excellently made, that they were very rugged and well adapted for the work they had to do. In certain points they excelled Allied devices.

But the maddening situation today is that when it comes to *radio controlled devices* of every kind, the Nazis are unquestionably first and are at the moment raising havoc wherever we come to grips with them. *And, sad to relate, in every case the Nazis have not invented or discovered anything new.* Quite the contrary, they are making use of many American ideas, having appropriated them for their own purpose. The U. S. Patent Office is bulging literally with thousands of ideas which are not made use of by our own War Department, probably because they are American ideas—and the old adage that "the prophet is not without honor, save in his own country," once more is true.

The Nazi radio controlled (Continued on page 436)

## Radio Thirty-Five Years Ago

In Gernsback Publications

How to Make a Wireless Control Relay,  
by H. W. Secor.

French Wireless Telegraph and Aero-  
phone Devices.

How to Make a Revolving Condenser,  
by A. Ward.

The Aerophone Automatic Signaling De-  
vice, by Rene Homer.

Wireless Banquet (Account of the first  
radio banquet in history given in honor of  
Dr. Lee DeForest.)

Condenser Phenomena, by C. C. Whit-  
taker.

FROM the April, 1909, issue of *MODERN  
ELECTRICS*:  
Majorana Aerophone Work, by A. C.  
Marlove.

Loud Talking Telephones, by the *Berlin  
Correspondent*.

To Supervise Wireless—first account of  
government control of American wireless.  
250-Watt Closed Core Transformer, by  
Carleton Haigis.

New Amateur Code, by John N. Mahl-  
meister.

### HUGO GERNSBACK

Founder

Modern Electrics	1908
Electrical Experimenter	1913
Radio News	1919
Science & Invention	1920
Radio-Craft	1929
Short-Wave Craft	1930
Wireless Association of America	1908

# Radio-Electronics

## Items Interesting



A CBS camera-man shoots a scene during one of New York's regular television broadcasts.

**T**ELEVISION every night is the lot of those fortunate enough to own television receivers in the New York area, now covered by three stations, WNBT (NBC), WCBW (CBS) and W2XWV (DuMont). These stations alternate their programs to give the television fans seven-night service.

Live shows, films, special subjects, and animated cartoons are part of the program. Pickups of local news and sports events are not uncommon, and advertising is of course assured a place on the program. A number of interesting "animated cartoon" feats are performed in the latter field, and advertising even has a puppet show on the air.

Part of the service enjoyed by residents of the metropolitan area is shared by fans in eastern Pennsylvania and southern New Jersey, who receive from Philadelphia the broadcasts of special events picked up from New York by Philco. General Electric also picks up a number of programs by relay from New York to help out its local programs in the Albany-Schenectady area, where a television service provides live shows, film and advertising.

Besides bringing entertainment to the present owners of television sets, these programs are of great value in developing the technique of post-war television, and should shorten the time required to get on the air with universal television after the cessation of hostilities makes manufacture of transmitters and receivers possible.

**F**M BROADCASTS will play an important part in post-war education, according to a statement made by George Jennings, acting director of the Radio Council of Chicago Public Schools, last month. The Radio Council operates WBEZ, used for FM classroom broadcasting in Chicago schools.

Plans have been made to link WBEZ with WIUC, of the University of Illinois, and use the combined stations in a network covering large parts of the states of Illinois, Michigan, Ohio, Indiana and others.

The Radio Council of the Chicago Public Schools has pioneered in classroom broadcasting and is now using FM broadcasts for classroom listening. Progress has been excellent, according to Mr. Jennings, who says:

"Station WBEZ has not yet operated a full school year, and only a very small percentage of our schools are equipped with FM receivers; but we expect, as it was with standard radio broadcasting, that there will come a time when every school in Chicago will have at least one FM receiver. Our experience has shown that if the programs and service are available, the schools will make arrangement to receive them in the classroom."

**R**EVOLUTIONARY changes in electronic and radio practices will come as a result of revealing the closely guarded data of American research at the end of the war, according to the recently issued annual report of the FCC. War-inspired experiments have not only developed new ways of doing things, but new things to do, the very nature of which must at present remain a secret.

The commission revealed that one expanded educational institution in particular employs several hundred engineers and physicists whose functions are to develop and perfect radio detecting and ranging, now referred to as Radar.

The government is sponsoring fundamental investigation through its channel, the National Defense Research Committee.

The commission also pointed out that the radio detecting department, FCC's largest unit, protected the radio channels from enemy hands by maintaining a constant patrol of the ether, checked 3,960 cases of suspected illegal transmissions, furnished direction-finding service for more than 300 aircraft including military plans and discovered sources of interference to commercial and military services.

**C**HICAGO will have a 40,000-watt television station early in the post-war period if plans of one of the city's largest broadcasters go through. Orders for the transmitter and elaborate studio equipment for telecasting—which will cost more than a quarter million dollars—have been placed with General Electric for delivery immediately after the war.

**T**ANTALUM, important constituent of electron tubes, is now so valuable that it is being flown to the United States from Brazil, where it is produced in abundance, according to a Chicago report last month. It comes here in the form of a rich ore, tantalite, and is refined in this country.

Used in grids and plates as well as in certain tube filaments, tantalum has a very high melting point as well as the valuable property of "cleaning up" the atmosphere inside a tube. Instead of emitting gases when hot, it actually absorbs those which may exist in the tube, thus improving the vacuum as time goes on.

Tantalum has a number of other important uses, being used in making cutting steels, for surgical purposes and on electrical contacts, as well as in optics, where a minute amount of the metal in glass increases the refractory power of lenses.

**A**NNOUNCEMENT was made last month by RCA of the development of two new high power triodes, RCA-9C21, a water-cooled type, and the RCA-9C22, a forced-air-cooled type. Both are recommended for use in the Class B modulator stage and in the plate modulated Class C final amplifier stage of high-power transmitters. Also they can be used in industrial R.F. heating applications when high power is required.

The new tubes may be used at maximum ratings at frequencies as high as 5 mc and with reduced ratings up to 25 mc. A feature of these types is the metal header which makes possible short internal connections between filament and filament terminals. In addition the grid is mounted directly on the header, the flange of which serves as the grid terminal. This provides an extremely short, heavy-current, low-inductance path to the grid. A pair of either type has ample power-delivering ability for the final stage of a 50 Kw. high-level-modulated broadcast transmitter.

**W**OMEN at the controls of broadcast studios will become increasingly numerous. The first group to be trained as a unit was graduated last month, after undergoing a nine weeks course of studio control and management.

The course was sponsored by the National Association of Broadcasters, as a means of obtaining replacements for the large numbers of men lost to the armed forces and vital war industry. The trainees have shown excellent adaptability and interest and there is every reason to believe they will handle their work at least as well as their predecessors, believe those responsible for the project.

All the New York networks co-operated in the project, lending instructors from their engineering staffs to train the controlletes, and providing facilities and apparatus for the classes.

# Monthly Review

to the Technician

**W**OE AND WNY, Radiomarine stations at Lake Worth, Florida, and New York City, respectively, are back on the air to handle traffic with ships at sea, according to a release issued by RCA last month.

In addition to handling commercial message traffic, subject to approval of the U. S. censor, the two stations will stand continuous watch of 24 hours a day on the international distress signal frequency, thereby enhancing the safety of men and ships.

Before the war, Radiomarine operated 15 coastal land stations for marine communications along the Atlantic, Gulf and Pacific Coasts, the Great Lakes and the Mississippi River. By January, 1943, all of these stations, except those on the Great Lakes and the Mississippi River, were closed voluntarily by the company, because of the shortage of manpower and in order to conserve material.

**A** STRONGER radio voice in post-war Europe was urged by James D. Shouse, vice-president of the Crosley Corporation, last month.

Just back from London, where he had been acting as consultant to the OWI, the manager of WLW-WSAI said:

"We in this country are evidently still complete neophytes in the use of potentialities of radio as an instrument for integrating the people of different nations in a common bond of understanding if not, in every case, of sympathy."

Explaining that from the British Isles it is possible to reach all of Europe through standard broadcasting, he said he did not believe "it will ever be possible for the U. S. to do as effective a job in Europe by means of shortwave" as the British can do by standard-band transmitters.

"I might venture the assumption," he stated, "that there is today, in the southern half of the British Isle, the greatest concentration of broadcasting transmitting equipment in the world."

"Whether as a nation we like to admit it or not, or whether we like to think of it or not, Europe after the war will still be a tremendously important part of any plan of world economy . . . It will, for many years, be an important thing that the American philosophy and American thinking about the world of tomorrow be kept crystal clear in the minds of the hundreds of millions of people on the Continent."

**R**ADIO CLUB of America officers for 1944, announced last month, include the following: President, F. L. Klingenschmitt; Vice-President, J. J. Stantley; Treasurer, Milton B. S'eeper; Recording Secretary, J. H. Bose (engineer affiliated with Major E. H. Armstrong at Columbia).

The club, which was founded in 1909, has just finished a successful year and has made arrangements to hear a number of excellent technical papers during the coming one.

**T**INFOIL, in thousands of strips about nine inches long and three-quarters inch wide, was dropped by German planes on southeast England late last February.

Called "flutters" by the English, these strips of paper-backed tinfoil, when released from planes at great height, flutter slowly towards the earth. It takes quite a while for them to reach the ground, where they were picked up by surprised and puzzled Englishmen.

The scheme, obviously, is to mislead the radio locators—the equivalent to Radar in England. The strips being metallic, and being dropped in quantity, naturally reflect the radio waves and thus tend to confuse the radar operators. Readings of the instruments, therefore, mislead the radar operators because the readings now appear as if a large force of airplanes were approaching. Thus a larger fighter airplane force will obviously be drawn to locations where they are not needed at all.

Incidentally, the trick is not original with the Germans, as according to *The New York Times* the Royal Air Force tried this device in attacks on enemy targets. The dispatch also stated that the Germans had tried the same trick in previous attacks on Britain.

**"S**YLVANIETTES" are the answer to the problem of shortages in the engineering staff of Sylvania Electric Products at Emporium, Penna.

When the shortage of engineers became so acute as to threaten breakdowns, both of the overworked engineers and the production schedules for which they were responsible, the department undertook a survey of the working record of hundreds of girls in production jobs.

Those girls who combined high educational qualifications with excellent pro-

**E**LECTRONIC train communication systems may help to make train wrecks a thing of the past, think officials of the Pennsylvania railroad. A train telephone which will permit communication with moving trains, between trains and between the locomotive and caboose of long freights, was installed last month on the railroad's Belvidere-Delaware branch, running north from Trenton, New Jersey.

The carrier current system is used. This avoids the drawbacks of straight radio, which might result in instructions being picked up by trains other than the one to which they were directed (as has happened to police radio). The carrier signals jump the distance from the rails or telegraph wires to the train receivers with no diminution in strength.

Although the idea is old, and experiments along this line have been made in the past, this is the first time wireless train communication has been tried in such complete form, and railroad men are watching the attempt with great interest.

**"O**UTSTANDING" is the term applied to radio's contribution to the War Bond Drive recently concluded, by members of the Treasury and OWI.

According to T. R. Gamble, "Radio's contribution has been without measure" while P. H. Cohen of OWI, was responsible for the term "outstanding."

Ingenuity of presentation, as well as free offering of station time, was a significant factor in the industry's success in forwarding the Fourth War Loan. Programs varied from tie-ins with fresh-to-the-minute news from the battle front to such special features as the well-known *Night Clubs for Victory* and the Boy Scout's *Mop-Up* over NBC.

duction records, plus good recommendations from the supervisors, were started out as Engineering Assistants. At the end of six months, the experiment has proven itself to be thoroughly justified, and the "Sylvaniettes" are now a permanent feature of the engineering staff.

"Most certainly the girls will be continued as assistants to the engineers," states W. Jones, manager of the Commercial Engineering department of the plant. "They have amply proved their worth, and have contributed perhaps as much as thirty per cent improvement in the department."

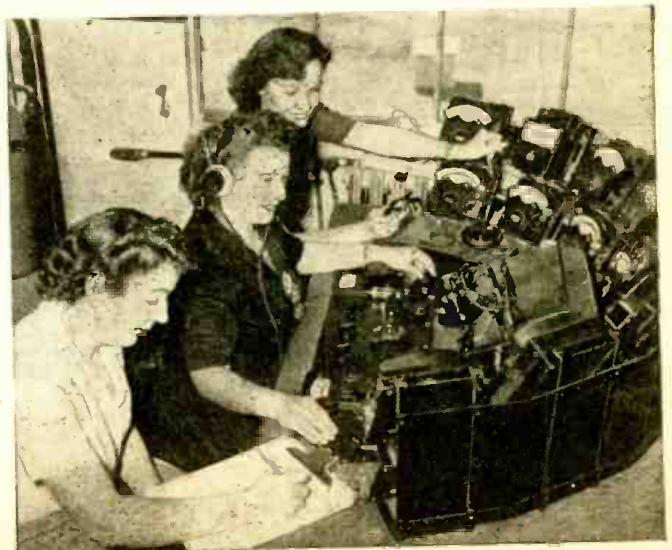

"Engineering Assistants" is the more prosaic title of these young ladies who have graduated from the workbench to the instrument table to relieve the shortage of trained technical manpower in their plant. Management says they will become a permanent feature of the future factory set-up.

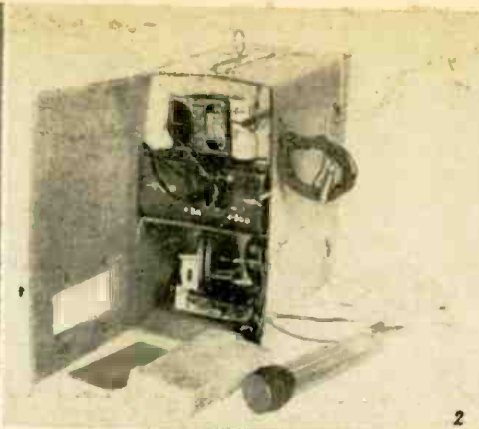
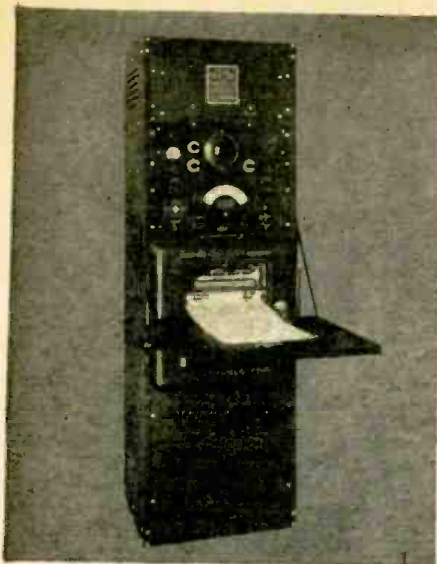

1—Raysonde receiver and automatic recorder.  
2—The sky-going weather broadcast station.  
3—Ready to go, with balloon and parachute.

# RAYSONDE-SKY RADIO

## A Transmitter which Broadcasts from the Stratosphere

By VERNON D. HAUCK\*

**S**INCE men first started to notice the weather, they have tried in vain to do something about it. At present, it seems that the day when man will be able to control the weather is still far, far away, so it would appear that the next best thing is to try to predict what the weather will be so that they can plan their lives accordingly.

Weather forecasting did not become a science until the invention of the telegraph provided a means whereby men in different

\*Chief Engineer, Friez Instrument Division, Bendix Aviation Corp.

parts of the world could quickly assemble information on current weather conditions in widely separated localities.

As the science of weather forecasting developed, the meteorologists found that the earth's weather was determined to a large extent by the activity of large masses of air, several miles in thickness, moving over the surface of the earth. The way in which these masses interacted with each other seemed to be a major factor in determining the weather at a locality and the future weather at other localities in the paths of the air masses.

This made it necessary to locate and keep track of the air masses, which, while all weather observations were being taken at ground levels, was very difficult. Soundings in the upper air were indicated.

Early attempts to probe the region of the air masses (the troposphere) included sending recording instruments into the air on free balloons, sending recording instruments into the air on kites, or with the advent of the airplane, attaching the instruments to airplanes in flight.

The development of the Raysonde, by engineers of the Friez Instrument division of Bendix Aviation Corporation, provided a practical and relatively inexpensive means of probing the air masses in such a manner that the results were available almost immediately. The word Raysonde is a contraction of radiosonde which means literally, sounding by radio.

### OBSERVATORY OF THE AIR

A complete weather observatory and battery operated broadcast station, the Raysonde is contained in a small cardboard box, about 4 x 8 x 9 inches, and weighs about 2.8 lbs. It operates continuously as long as the battery holds out, and makes continuous observations of pressure, temperature and humidity, communicating this information by radio to the receiving station.

It is carried aloft by a gas-filled rubber balloon, about 6 feet in diameter, transmitting information about the weather it encounters during its journey, until the balloon bursts due to the decreased pressure. It then descends to earth supported by a parachute, where it may be recovered for re-use or salvage.

Here's how it works: The transmitter is a small 1-tube affair (Photo 2) using a 3A5 tube (duotriode) connected as shown in Fig. 2. One triode section is connected as a 72 Mc. R.F. oscillator which sends a continuous wave signal through the antenna, to which it is inductively coupled. The other triode section is connected as a 1 Mc. R.F. oscillator, with grid bias resistance high enough so that intermittent operation results, i.e., it will oscillate, drawing grid current, until the R.C. grid circuit accumulates a negative charge high enough to block the oscillations in the tube. At this point, the tube ceases its oscillations and allows the charge on the grid condenser to leak off through the grid bias resistance. The two triode sections are connected so that each time the 1 Mc. oscillator starts to oscillate, it causes the 72 Mc. oscillator to stop oscillating momentarily. Thus, the antenna will receive a 72 Mc. carrier wave periodically interrupted with the same frequency that the 1 Mc. oscillator is interrupted. In practice, this interruption rate is made to vary from 5 c.p.s. to 200 c.p.s., so that the carrier interruption is equivalent to 100% modulation with a square audio wave of 5 to 200 c.p.s.

The frequency can be varied by changing the grid resistance of the modulating oscillator. Hence, if the weather conditions we are trying to measure can be made to produce changes in resistance, the frequency of modulation can be taken as an indication of the magnitude of the weather element.

### THE METEOROLOGICAL UNITS

In the case of temperature, it is only necessary to use an ordinary resistor with a high temperature coefficient in order to produce this effect. In order to keep its ther-

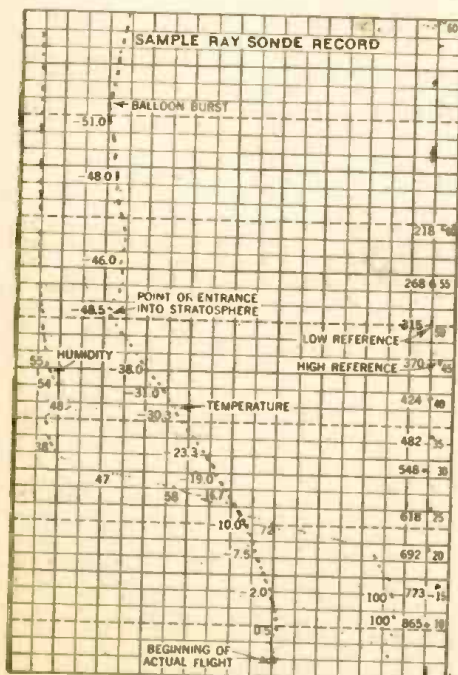

Chart above is an actual record of a flight. Marks along the right edge are made by the reference frequency, described in the text.

mal inertia to a minimum, so that it can follow rapid changes in temperature, it is sometimes built in the form of a small glass capillary tube filled with a special electrolyte having a high negative temperature coefficient of resistance. The resistor illustrated is a special composition resistor.

The humidity sensitive element is an ingenious mechanically variable resistor, actuated by several strands of blond human hair. The hair expands and contracts with changes in humidity, varying the resistance of the resistor element. This element is now being replaced by a newly developed electric hygrometer, which consists of a strip of plastic material coated with hygroscopic solution, so that the resistance across any two points on the strip is a function of the humidity to which it is exposed. The illustrations are of a Raysonde using this new humidity unit.

The pressure unit is the heart of the device. It consists of a pressure operated switch which alternately switches the temperature and humidity units into the modulating oscillator grid circuit. This unit is illustrated in Fig. 3. It is composed of an aneroid barometer diaphragm, arranged so as to push an arm across a commutator. The commutator is made up of a series of silver segments separated by insulating segments. It is hooked up to the temperature and humidity units so that when the arm is on an insulating segment, the temperature unit is connected into the grid circuit, and when the arm is on a conducting segment, the circuit is completed to a small SPDT relay which connects the humidity unit into the grid circuit.

Thus, as the Raysonde rises through the air, the aneroid diaphragm expands, moving the arm over the commutator in one direction. Each time the arm passes from an

insulating segment to a conducting segment, or vice versa, the modulating frequency undergoes an abrupt change. Thus it is possible, by counting the number of changes, to deduce the contact on which the arm is resting at any time and hence, knowing the calibration of the pressure unit, what the pressure is at that point in its flight.

To aid in identifying the contacts, every fifth conducting segment is made twice as thick as the others and is connected to a fixed resistor. This produces a frequency of approximately 190 c.p.s., which is known as the "reference frequency." This reference frequency is also useful in keeping track of any shifts in audio frequency caused by low temperatures and changing battery voltages. If the reference frequency is observed to drift slightly, it is known that the temperature and humidity frequencies have also shifted from their correct values by a proportionate amount, and can thus be corrected accordingly.

The equipment necessary to receive signals from the Raysonde is shown in Photo 1. It consists of a vertical center-fed dipole antenna, a superregenerative receiver, a frequency meter in which the modulation frequency is converted into a meter indication and a photo-electric type recorder in which the meter indication is recorded on a moving chart.

#### WEATHER RECORD FROM THE SKY

A typical record taken during an actual flight is illustrated in the chart on opposite page. Two complete graphs are automatically drawn, showing the variation of temperature and humidity against altitude. The altitude at any point can be found by counting the number of times the reference signal was printed and consulting the calibration curve of the pressure unit. Note the sensi-

tive response of the humidity element which immediately registers a transition from a dry air mass to a moist one and vice versa.

It is from hundreds of records such as this, taken at widely scattered points on the earth's surface that meteorologists can keep track of the earth's air and its condition.

The height to which the Raysonde will rise before the balloon breaks will vary from 8 to 12 miles, usually in about an hour to an hour and a half.

During this time, it may be carried a great distance in a horizontal direction. During the summer, when the winds aloft are relatively weak, and vertical motions are predominant, the Raysonde will rise almost vertically, and may fall 10 or 20 miles from the point of release. During the winter, however, when horizontal motions of the air are predominant, the Raysonde may travel 100 or 150 miles before falling.

The Raysonde bears a prominent label on the box, offering a reward to the finder for returning it to the owner. The number of balloons which are so returned depends on the location of the point of release, and the type of country in the direction of the prevailing winds. The greatest percentage of returns are obtained from cultivated farmland and pastures, the least percentage from locations where mountains or water lie ahead. In the former instance, returns may run as high as 90% of the total number released, in the latter, as low as 5%. On account of the prevailing westerly winds over the United States, returns from stations along the Atlantic Coast are poor, most flights ending up in the ocean. Pacific Coast stations likewise have a poor percentage of returns because of the mountains to the east. On the other hand, stations in Nebraska, Illinois, Missouri, etc., enjoy a consistently high percentage of returns.

Fig. 2, schematic below—Diagram of the transmitter and its measuring devices.

Fig. 3, right—A view of the transmitter and the pressure unit which operates it.

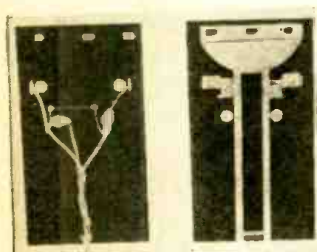

Above—Humidity recorder and special resistor-thermometer.

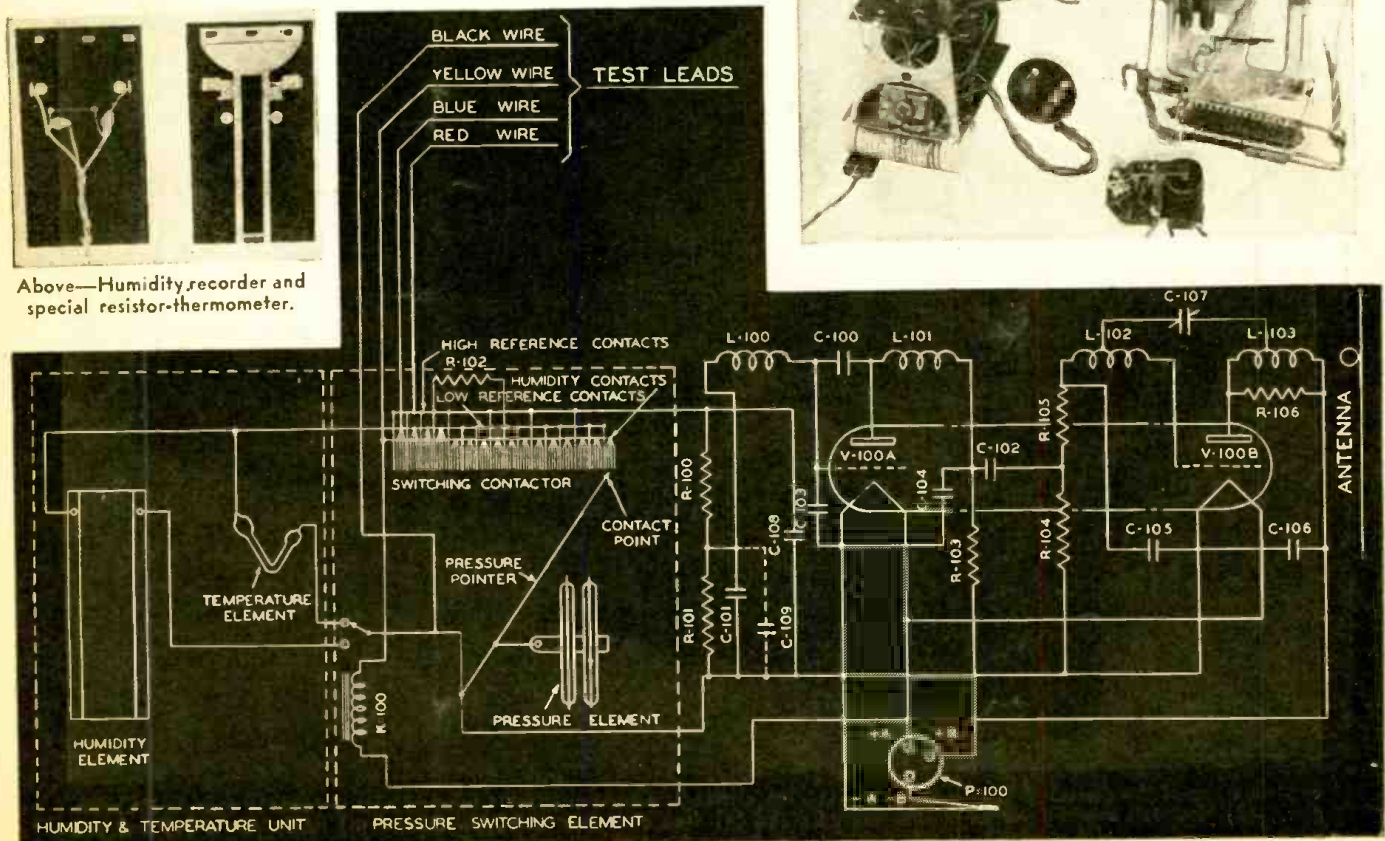
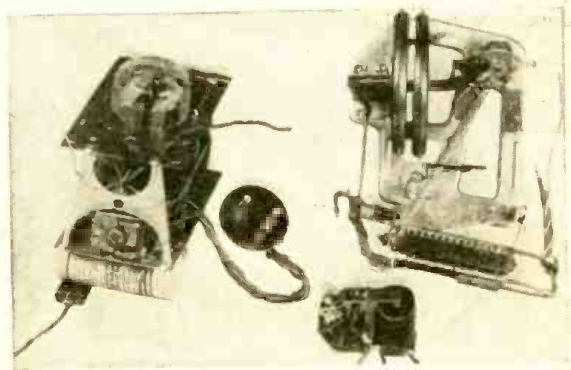

**W**HAT may turn out to be the greatest radio-electronic development since Marconi, is the subject of this revolutionary article. The Radium-Radio Receiver, with its cold radio-electronic tube, which uses no batteries or outside current of any kind, is so astonishing and so far-reaching in its import, that all of our radio receivers will soon undergo a complete change.

How this great invention came about and how the inventor was persecuted by the large radio-electronic interests forms an equally astonishing adjunct to the annals of radio history.

RADIO-CRAFT therefore is not only proud in presenting the story of this amazing invention but also in exposing the nefarious work perpetrated by the powerful interests who conspired to block the Radium-Radio Receiver. It is certain that in so doing, RADIO-CRAFT has rendered a signal service to the public at large. The receiver will be made after the war.

# RADIUM-RADIO RECEIVER

By MOHAMMED ULYSSES FIPS

It has always struck me that our present radio means, as far as our radio tubes and radio sets are concerned, were nothing but clumsy makeshifts and that much better radio devices could be evolved in bringing radio programs to the masses.

Our radio sets and radio tubes have always suffered from too great a complexity, which necessarily increases the cost of the final receiver to such a degree that it often could not be acquired by the man of very moderate means. It had always been my dream some day to produce a radio that would have EVERYTHING and that could be sold for less than \$10.00, yet be a really first-class set. If such a set were mass-produced, millions could probably be marketed for \$5.00. These considerations were in my mind ever since the crystal set days.

Then we had a radio set without any batteries whatsoever. It didn't consume cur-

rent from the lighting mains and it could be easily transported and used anywhere. It did not have resistors and a multiplicity of condensers—electrolytic and otherwise. It was small and it was cheap. Best of all, the reception was also crystal clear. But with the coming of the vacuum tube radio set everything was changed and the entire radio industry followed blindly in a groove in which it has been ever since.

## THE COLD RADIUM-RADIO TUBE

Several years ago I started work on my *Radium-Radio Tube*—an electronic tube which requires no batteries of any kind. After the first few tubes had been constructed, I was encouraged a great deal, so much so that I finally evolved the revolutionary tube which is described in

this article. Shorn of all technical language, the new cold Radium-Radio electronic tube makes use of radium for its electronic emission. This is not a new thought but is as old as radio itself, but up to now no such tube could be constructed because radium emanates both positive and negative emission, making such a tube useless. I then conceived the idea of using a magnet inside of the tube, using one pole of the magnet as a plate. Now radium, as we all know, emits two kinds of rays—the so-called Alpha and Beta rays. Both are deflected by an ordinary magnet but, fortunately, in opposite directions. Thus, by making the plate, or cathode, one pole of the magnet, I can utilize the Beta rays which in reality are ordinary electrons, just as they occur in a standard vacuum tube. Then I can utilize the Alpha rays on the other end of the magnet. I use these Alpha rays in conjunction with the well known "multiplier"

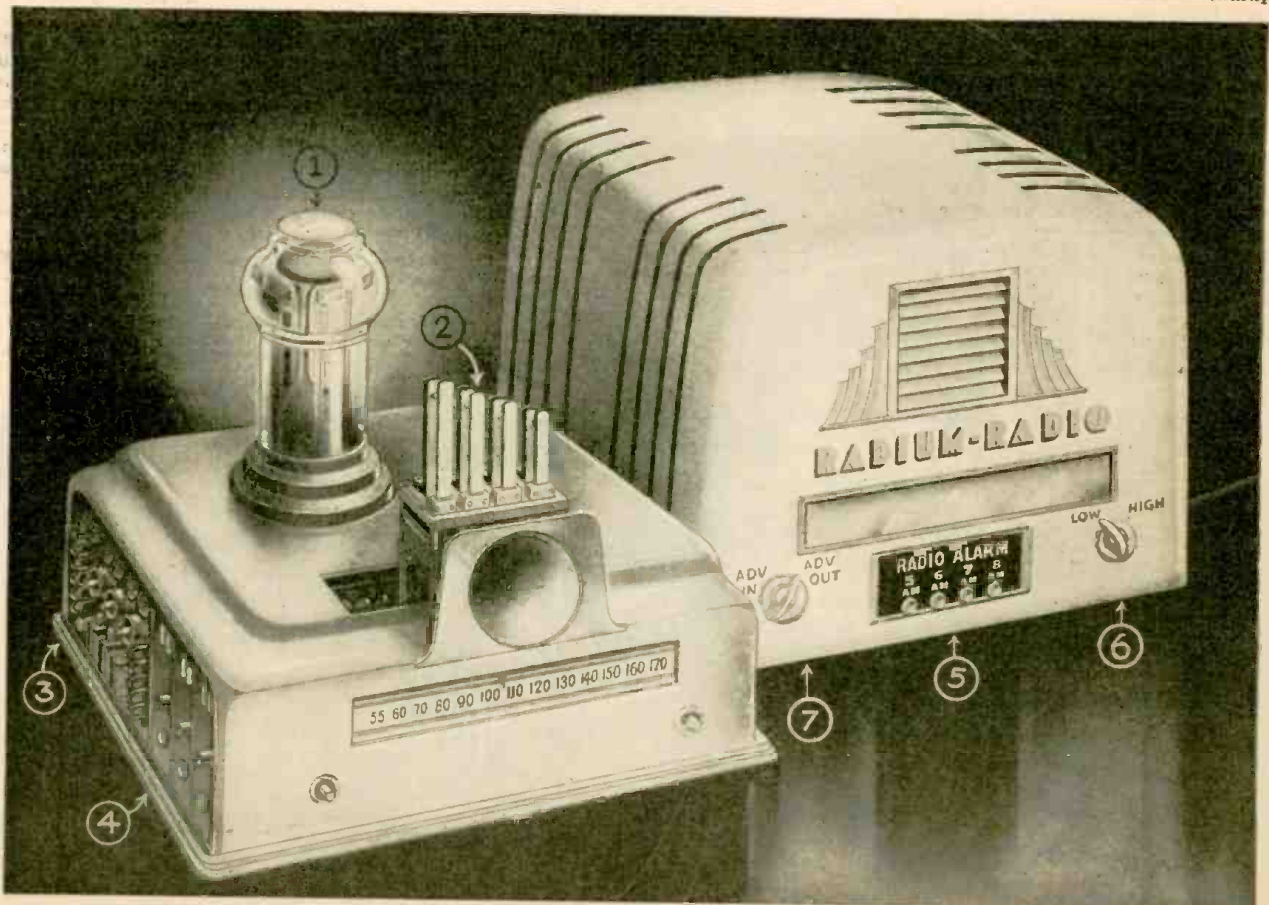

A photograph of the perfected Radium-Radio set. (1) The new radium currentless radio tube. (2) Tuned reeds to operate the radio alarm. (3) Electronic memory control to eliminate ad plugs. (4) Iron dust core tuning inductance. (5) Radio alarm. (6) Low and high volume knob. (7) Switch to cut in or cut out objectionable radio advertising plugs.



## RADIUM-RADIO TUBE RA-RA 4-1

**RADIUM-OPERATED** radio tubes have been suggested since the earliest days of the industry. One great obstacle has hitherto prevented the use of radium for the job. While a cathode surface coated with radium (or a radium compound) would emit electrons, and while that emission would last for centuries, producing a tube with a fantastically long life, the hitch is that radium emits both positive and negative particles. Thus the anode would remain at the same potential as the cathode, and there could be no external flow of current.

The method used to solve this problem in the Radium-Radio (Ra-Ra) tube is simplicity itself, the only surprising thing about it is that someone has not stumbled on it earlier. The alpha and beta rays of radium are deflected by an ordinary magnet, but in opposite directions. The anode of the Ra-Ra is a magnet. (See diagram.) The pole nearest the cathode is so shaped that the beta rays, which are ordinary electrons, are deflected to the first of the multiplier plates which form an essential part of the tube. The alpha rays are bent very slightly in the opposite direction, and impinge on the pole-piece, or anode, giving it an extremely high positive charge.

Emission of beta rays is controlled by the grid, which for electron-optical reasons is shaped like the

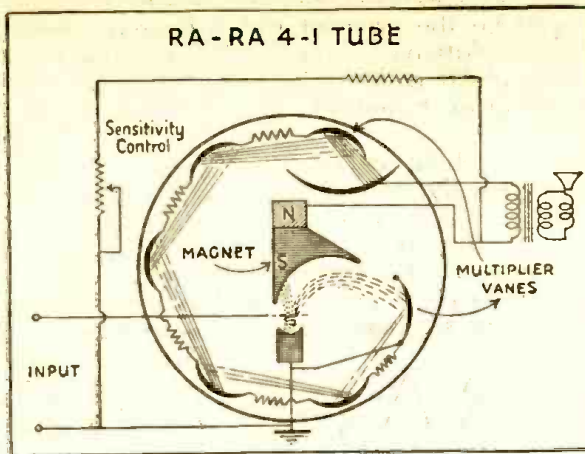

grid of a thyratron. Means may be provided for keeping it negative with respect to the cathode. This tends to accelerate the positive alpha particles, and permits raising the anode to a higher potential, while not affecting the control of the beta rays,

or electrons emanating from the cathode. A lead from the magnet-anode is brought out to the external high-voltage terminal of the tube. This is also connected through a resistor to the multiplier bank. The latter is constructed according to standard multiplier practice, resistors inside the tube maintaining each multiplier cathode-plate at a suitable voltage below the next one above it, etc. The lead from lowest-voltage multiplier plate is returned to the emitter, which is also grounded. A variable resistor controls emission and acts as a volume control when the tube is used in radio reception.

The final collector is returned to the magnet-anode through the load, which may be a loud-speaker, relay or indicating device.

Magnetic shields, which assist in controlling and focusing the flow of electrons from plate to plate, are not shown, as they would unnecessarily complicate the schematic and drawings.

Under test, the Ra-Ra 4-1 worked well from 1 cycle to 300 megacycles. The electrode spacing of the tubes so far constructed has been adapted to work at audio and low radio frequencies, and there is little doubt that tubes designed for the work will oscillate far into the UHF region.

S. H. MANN,  
Engineer in Charge, Ra-Ra Development

device and thus increase the electrical energy obtained from the radium to operate the tube.

Above I have given full technical data showing how a workable tube, which requires no outside electric currents of any kind, is constructed.

Best and most important of all, the theoretical life of the Radium-Radio Tube is as long as the life of radium—2500 years. There being nothing to burn out, nothing used up except the infinitesimally small amount of radium, the tube for all practical purposes will be everlasting. I have had tubes of this type in constant operation for over two years and they keep on working uninterrupted, without any attention of any kind, day and night, month after month.

The reader may ask: "By using radium in the cold Radium-Radio Tube, does this not make such a tube very expensive?" The answer is "no." Radium has come down in price until now it only costs \$25,000 per gram, where originally it cost \$150,000 per gram; but in my tube I only use the merest speck of radium, so little, in fact, that only about 30c worth is put into one tube.

But I was not satisfied just to revolutionize the radio tube and all that goes with it—I wanted a radio set that would be a fit companion to this remarkable tube. After I had constructed a number of them,

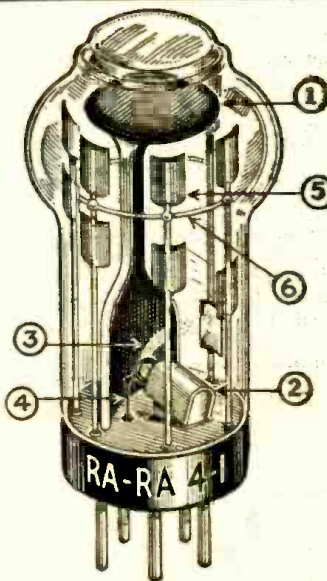

The above illustration shows an idealized view of the new tube. (1, 3) Reflecting parts of the magnet. (2) Lead container with radium. (4) Grid. (5) Reflecting vanes. (6) Glass vane supports. For clarity's sake, the resistors have not been shown in our illustration.

it was found that the sensitivity as well as the power of these tubes was unbelievably great, so great, in fact, that for the average home-radio set, I require only a solitary tube. Indeed, one tube is so powerful an output, due to its terrific electronic emission, that instead of using a volume control on the speaker, I had to use what I call a "volume throttle." The power of the tube, in other words, is so great that if the entire power of the single tube were turned loose into the loud-speaker, it would shatter it and burn out the field windings. For this reason, for the first time in a radio set, it was necessary to incorporate small fuses in the speaker circuit to protect it!

Another new and quite revolutionary point of this set is that it is never turned off. Having no batteries or no electric current to save, it is therefore unnecessary to turn the set off completely. The volume throttle is constructed in such a manner that when you turn it to "low," the receiver will operate at a mere whisper.

You may ask: "Why do this? Why not turn the set off entirely?" The answer is very simple. Radio engineers for many years have tried to find means to keep a set turned on at a low volume, then when important news came over the radio set, it could be turned up automatically, so that the owner would get the urgent broadcast

(Continued on page 434)

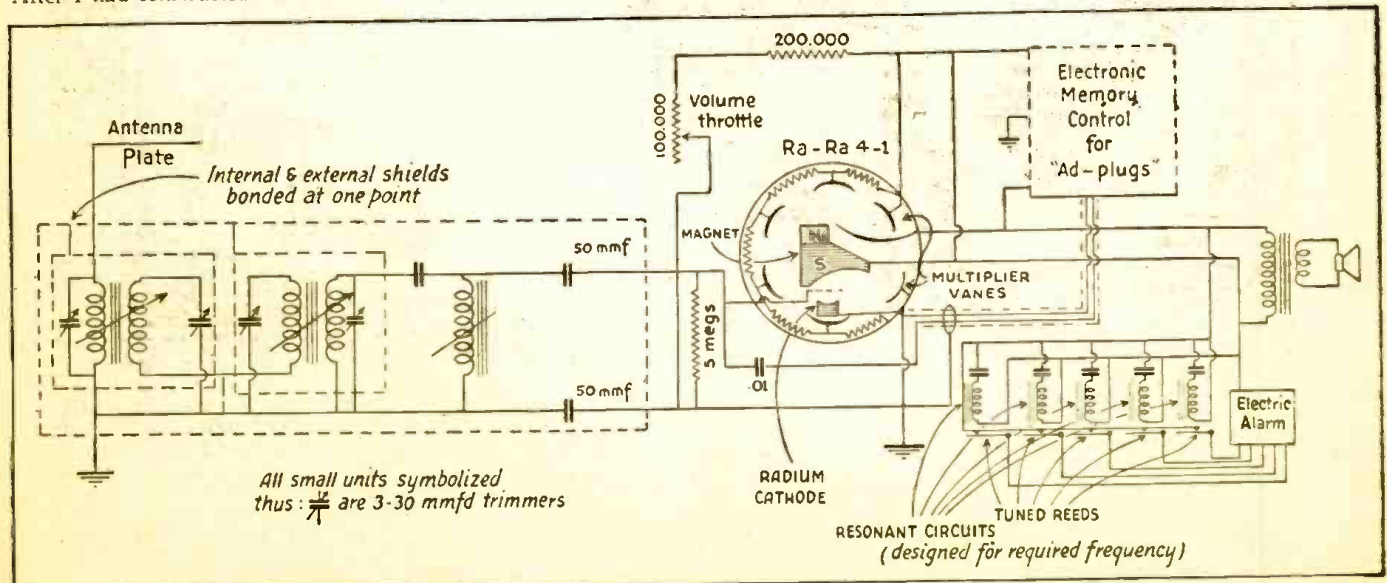

A simplified diagram of the new radium-radio set. At the left we see the iron dust core tuning inductances and how they are connected with the RA-RA 4-1 tube. Also of interest are the tuned reeds which are energized by special gongs or whistles from the broadcast station.

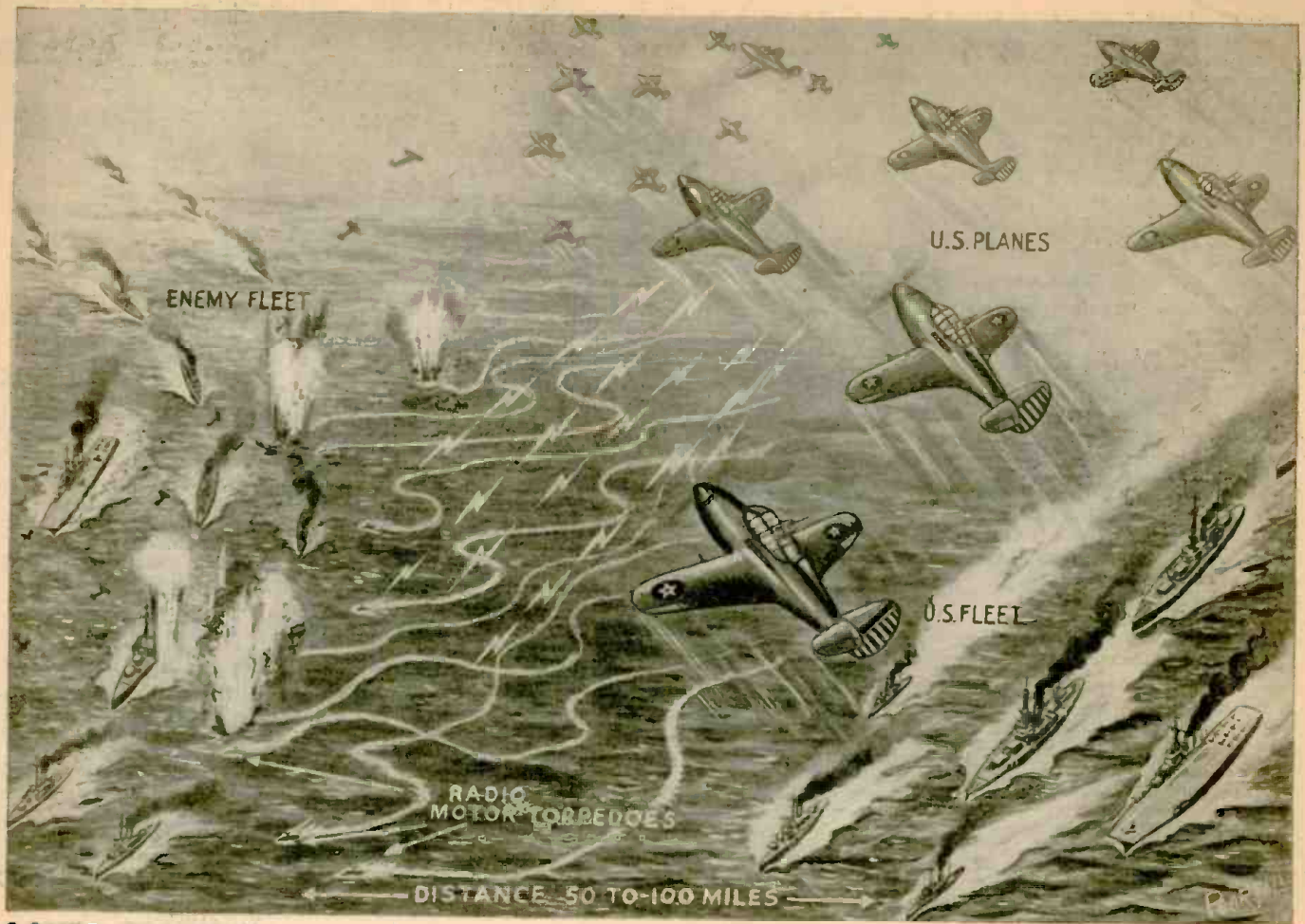

COVER FEATURE:

# RADIO MOTOR-TORPEDOES

By HUGO GERNSBACK

**T**HE present war has shown that large capital ships rarely fight it out with other capital ships. The huge monster battleships are usually held in reserve, wherever possible for the balance of seapower; they engage the shores of the enemy rarely. If they do, they must make sure that there is a sufficient air umbrella to protect them from enemy aircraft.

No longer are large battleships safe near the enemy shore. The sinking of the two English battleships—*The Prince of Wales* and the *Repulse*—proved this sufficiently off the coast of Malaya. These two battleships, not having an aircraft umbrella, were quickly sunk by Japanese torpedo planes. Likewise, the Italian capital ships, when still under the Axis rule, stayed safely in their harbors and did not venture forth to give battle to the English and American Navies.

Air power has changed naval tactics considerably, and even if one country has an overwhelming superiority in naval equipment, this does not make for an automatic or certain victory, as would have been the case before the advent of air power. Today, when one naval unit attacks another, a handful of airplanes equipped with torpedoes can raise fearful havoc with the opponent's fleet. For this reason, it is safe to predict that future decisive naval battles will be fought without the two fleets even glimpsing each other. This has already

been shown by our own engagements in the South Pacific with parts of the Japanese fleet, and the tendency will increase from now on. Whenever we are attacking a Japanese fleet, it will be from a safe distance anywhere from 100 to 150 miles away. Our Air Force will bear the brunt of the preliminary fighting. We will try to sink or damage as many of the Japanese naval units as we possibly can from the air, before our capital ships close in for the kill.

**L**ONG distance torpedoes, which are combined with a type of motorboat craft and which are controlled by radio from airplanes, form the substance of this article.

These radio super-torpedoes have enough fuel to travel over a distance of several hundred miles in the open sea. Their speed is sufficiently great and the radio control is such that they become difficult targets for the enemy.

The present day aerial torpedo, launched from an airplane against an enemy vessel is a formidable weapon, but if the opposing force possesses sufficient air-power—that is, fighting planes—it can then down the torpedo plane or planes, so that the latter never get a chance to come near the enemy fleet.

We need, therefore, something better, and the means which are described here seem to fill that need.

As is well known, the ordinary torpedo usually is powered by compressed air. It only runs for a few thousand yards at the most, then if it does not strike its target, it automatically sinks before it is captured by the enemy, or does damage to its own fleet. What then is needed is a long distance torpedo which can travel, if necessary, 100 miles towards the enemy, then if no strike is made, it can return to its own fleet with full safety to the latter. For this purpose, we require not an ordinary torpedo, but rather a sea-going motor speedboat combined with a torpedo as shown in our illustrations. In the forward part of the boat is the war-head carrying several thousand pounds of high explosives, similar to those in regulation torpedoes. The device therefore is nothing but a super-torpedo, which instead of using compressed air (or electric batteries, as some types now use) has powerful, standard motorboat engines. There is also sufficient fuel aboard so that the craft can run up to a distance of 200 miles, if necessary.

Like a regulation torpedo, this motor-torpedo carries no one aboard the craft. But here the similarity ends. The usual torpedo is launched on its course and then by means of its gyroscope and other elec-

tric devices, it speeds toward the enemy craft which it usually sinks, or heavily damages, on impact with it. The radio-controlled motor-torpedo also has its share of automatic devices, but, most important, its radio "brain" which does the steering has the latest possible refinements, so that it not only can be made to veer from right to left, but it can suddenly swerve almost at right angles, cut figure eights, run around in circles, etc. In practice this radio super-torpedo would work out somewhat as follows:

The motor torpedoes are carried on any suitable naval craft of the fleet. When ready for battle, they are lowered into the water, the engine is started and, after short preliminary tests, the craft is sent on its way in the general direction of the enemy. At the moment the motor-torpedo is started, an airplane which has on board the radio control which is to guide it, also takes off from its carrier, or is catapulted from its mother battleship. The torpedo is painted in such a color that it is easily visible from aloft. Note that this particular torpedo does not submerge entirely as does the regulation type. There is, however, very little of its upper structure visible and it runs almost awash. Most prominent is its antenna over which it receives the impulses from the guiding control plane.

The radio operator on board the radio-control airplane has in front of him a keyboard and the other radio transmission devices making it comparatively simple to steer the radio motor-torpedo from above. These radio controlled war engines are fast craft, running over 40 miles per hour, even in a rough sea. For the time being, the enemy is nowhere visible. But in the meanwhile, our reconnaissance airplanes have already reported the general position of the enemy fleet. The radio-control airplane therefore knows the exact direction and he will now speed the radio motor-torpedo in that direction until the enemy fleet becomes visible.

I should mention here that it is quite feasible for one radio-control plane to direct more than one radio motor-torpedo. As many as three in a group can thus be guided by a single plane. The observer, anywhere from 5,000 to 20,000 feet up, can follow the course of the several torpedoes without too great difficulty. If the weather does not permit it, he will have to come down, so that with his binoculars he can actually follow the craft's course. He will

be greatly aided in this because the torpedoes make quite a visible wake in the water, which helps him in locating them.

Automatic or semi-automatic apparatus may assist in the control and guidance of these super-torpedoes, making it unnecessary for the observer to concentrate all his attention on one. There is some reason to believe that some kind of automatic guiding apparatus is already in use on German aerial radio rockets. (See *Radio-Craft*, February 1944, page 267, for a note on certain features of these rockets.)

From here on it becomes a battle between the control airplane and the enemy's air fleet. Naturally the enemy will do all in its power to down the control plane, if he can do so. Furthermore the radio-control plane, being the driving brain of the torpedoes, will be sought out by the enemy—if he can find it. For that reason, it is advisable for practical purposes to employ a number of planes. The enemy therefore cannot guess which of the planes is the guiding plane. As all of the planes are fighter planes, the enemy will not find it too easy to single out the one plane he most wants to down.

It will be of little use for the enemy to try and bomb the motor-torpedoes, for several reasons. In the first place they travel at too high a speed. Secondly, being very small targets, it will be practically impossible to make a bomb-hit on them. But now let us suppose that we have out-manuevered the attacking enemy airplanes. It is by no means necessary for the control airplane to get right over the enemy fleet. There is no such intention. By now our planes, including the control plane, have risen to a great height and the radio torpedoes are steered on their course. Remember, they travel under their own power. Our radio-control airplane may actually still be miles away from the enemy fleet. Thus it does not get within the range of the enemy's anti-aircraft fire, or anywhere near it. If now the enemy tries maneuvering to evade the motor-torpedoes, our little craft can do likewise, only much faster, and no matter how fast the enemy tries to turn, the motor-torpedoes can do it quicker, because they are so much smaller. The radio operator aloft can then steer each torpedo into the final run where it must hit its target. The control operator can even guide the torpedoes around the fleet and attack the enemy from the rear.

The objection will be made that the enemy will be certain to bring into play his

full gunfire directed toward any torpedo when it comes within gun range and try to blow it up before it can strike one of his ships. This is quite true, but consider that the motor-torpedo runs at high speed and therefore makes a most difficult target. The radio control operator aloft can further safeguard it by running it in a zigzag course. This again makes a hit much more difficult for the enemy's guns, and the chances for the motor-torpedo to strike its target will therefore be all the greater.

That an occasional gun hit will be made against one of the torpedoes, and blow it up before it gets near a ship or transport, is a foregone conclusion. Not every torpedo can possibly hope to find its mark but note that each of the radio-control planes can guide up to three motor-torpedoes without too much difficulty. It should also be realized that we will not attack the enemy just with three torpedoes alone. We may attack with a dozen or more, at the same time by using a number of radio-control planes, each operating on a different wave length, for its own flock of torpedoes. All this is possible and feasible today, with means well known in the art.

As I have pointed out in my former articles\*, it is almost impossible for an enemy to "jam" a radio-controlled weapon today. Therefore this means of beating the motor-torpedo is immediately ruled out.

If all runs well for us, we therefore will be in a position to secure a number of sure strikes by means of these radio-controlled torpedoes and sink or otherwise damage the enemy fleet and probably cripple a good many units.

There are a number of other uses for these radio motor-torpedoes, particularly for night warfare, against harbor installations, etc., which for security reasons cannot be divulged in this article.

The idea of radio controlled naval craft is by no means a new idea. During World War I, the English Navy successfully piloted a radio-controlled ship into the harbor of Zeebrugge (Belgium), used by the Germans at that time as a submarine base. This particular craft had no one on board and was guided to its destination purely by radio into Zeebrugge harbor, where it was blown up and sunk. This effectively bottled up the German submarines and their outlet to the sea for many months.

\*The Radio Glider Bomb, *RADIO-CRAFT* November, 1943. Radio Pilot Mine Destroyers, *RADIO-CRAFT*, December, 1943.

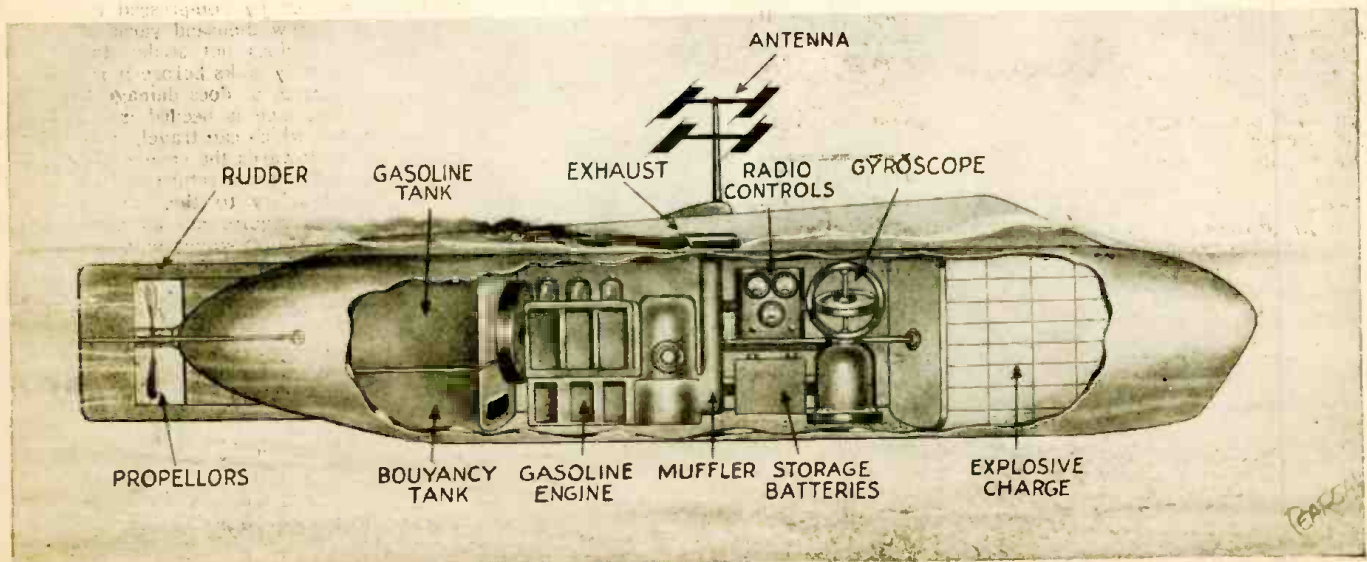

One observer-pilot may handle the necessary controls to keep two or more torpedoes accurately on their way to the distant target.

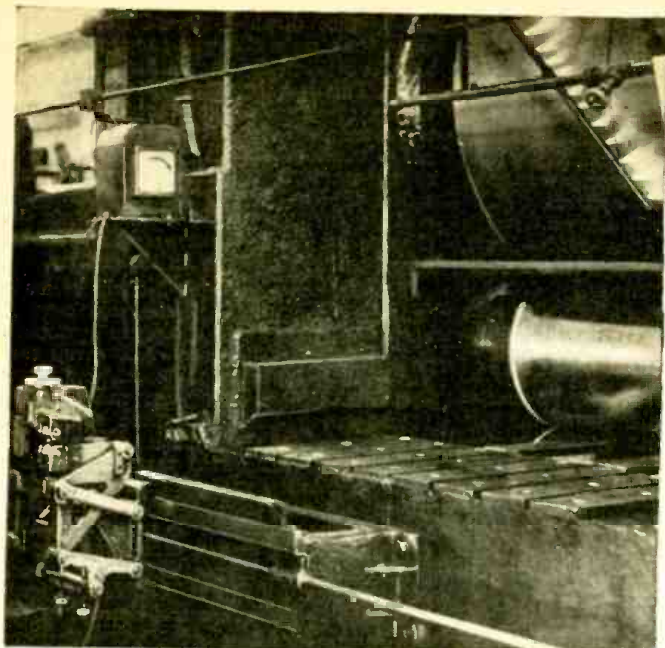

Courtesy General Electric Co.

Thickness of rolled steel controlled by the electro-limit gage.

# Industrial Electronics

## PART II—MEASUREMENTS

By RAYMOND F. YATES

Electron tubes are uniquely adapted to making fine measurements. They are readily affected by changes in size or motion too small to be detected by non-electronic means. Such infinitesimal variations are amplified with absolute linearity to operate large and easily read meters. Measurements are thus made of microscopically small quantities, and the human element is reduced to a point where it has a relatively small effect on the accuracy of results.

**I**N THE preceding installment of this series we outlined a number of impulse generators used in the control of machinery. An impulse generator refers to some physical or electrical force used directly or indirectly to affect the grid charge on electronic amplifier tubes. In the present article of the series, an attempt will be made to show how these impulse generators are applied to everyday machinery.

One reference was made to capacitance as an impulse generator. Certain electronic circuits, such as that shown in Fig. 1, can be made extremely sensitive to the slightest change in the position of one of two separated metal plates, the air between them functioning as the dielectric. This very principle is used on an electro-limit gage now installed on the rolling mills in the steel industry. Sheets of steel are continuously "miked" by a small millimeter calibrated in terms of thousandths of an inch.

A lever with a roller on its end makes constant contact with the sheet as it rolls through the mill. The opposite end of this lever carries the movable plate of the control capacitance.

### A STRAIN-MEASURING TUBE

One of the most ingenious electronic devices for mechanical measurements that has so far appeared is illustrated in Fig. 2. With this relatively simple device which employs only one tube, extremely small displacements due to tension, compression or torsion in a stressed member, may be accurately measured. A special tube is used in this device. This is so constructed that a direct mechanical connection is established between one of the tube elements and the actual part of the machine that is to be measured for displacement. Any bending or twisting of this member is therefore directly communicated to the vacuum tube itself through displacement of anodes. This changes its internal resistance. The changes are recorded on a specially calibrated meter. Students of electronics, as it relates to machine control, should be sure to bear this promising principle in mind. Much will be heard from it in the future.

Another excellent example of the extreme versatility of electronics appears in Fig. 3. Here we have a scheme used for rapid routine testing of insulation on enamelled wire.

We note that the wire passes through two pools of mercury. Obviously if a bare portion of the wire is exposed in each mercury pool, the two pools will be connected together and the grid bias of the tube will be short circuited. A mechanical scraping device which exposes the wire to test is not shown.

Many physical, chemical and electrical tests are made with the use of electronic equipment. Numerous testing devices have been invented that are now standard equipment. The oil industry has found many uses for electronic apparatus. Fig. 4 shows one of these uses. Here we have a device which measures the viscosity or "thickness" of oils. Each time the steel ball in the glass tube passes through one of the small coils wound around the tube, a click is heard in the telephone receivers and the needle of the milliammeter jerks. It is only a step from this simple mechanism to an interval recorder that sets the transit time down with an accuracy of plus or minus .001 second.

### SYNCHRONIZATION SOLVED

Synchronization, that is, timing or coordinating one movement with another, has always been one of the great problems of industry. For instance, a series of motors stationed some feet apart drive a long conveyor belt. If one motor revolves slightly faster than the rest, the belt will sag at one point and become taut at another. Fig. 5 shows how electronics solves this problem. Thyratrons are installed in the motor circuits for field control. An idle pulley rides the belt and is mechanically connected to a magnetic reactor located in the tube circuit. Thus, as the idle pulley moves either up or down the reactance is affected in such a way that the motor speed is controlled within narrow limits.

Such applications are elementary achievements for the ubiquitous electron. The same may be said of the arrangement in Fig. 6, where a thyatron-photoelectric cell combination is employed to synchronize the action of a cut-off shear with the printing cylinders of a large color press producing package wrappers. Unless the cut-off is properly timed with the printing impressions, the packages will not be wrapped in register. A little study of the diagram will show how the lamp and phototube arranged above the web and focused on a spot on the pa-

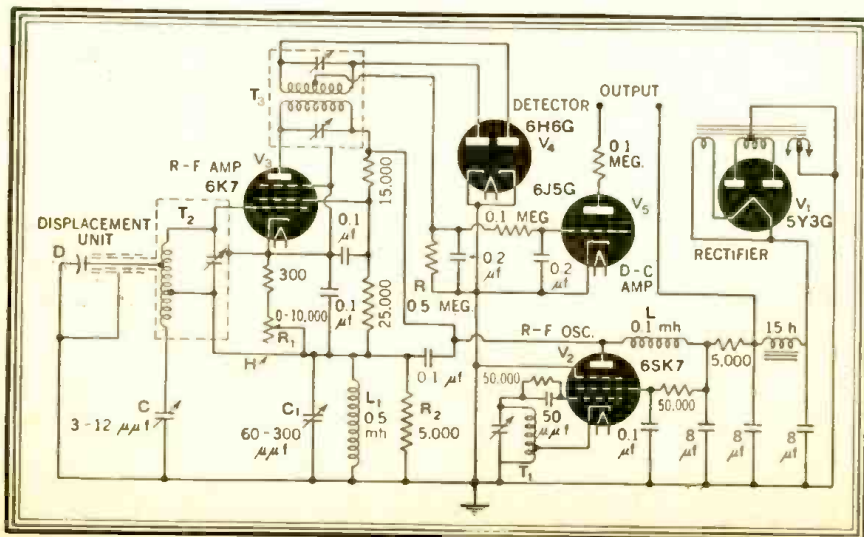

Fig. 1—Typical circuit of a displacement gage such as might be used in the photo above.

per are employed to keep the wrappers in step.

We have already had some three to four hundred applications of photocells in industry with hundreds more to come. Many of these applications will be so simple and will involve such elementary equipment that any young radio man with a fair grasp of electronics will be able to make installations. A case in point is shown in Fig. 7. Here two photocells are applied to the web of a folding machine for paper napkins. Alignment is very important in this case. Should it be destroyed, the attention of the operator is attracted by an alarm.

Counting is one of the first services rendered by photoelectric relays. Here again, radio servicemen in the future may easily make such installations. Counting may be fast or slow. Even the revolutions per minute of revolving shafts may be counted in the manner shown in Fig. 8. This is only one of the innumerable methods that may be used.

When the red hot bar of steel reaches the photoelectric cell shown in Fig. 9, enough radiant light energy is received by the cell to operate it. Then, working through thyratrons, the cut-off saw is brought forward. The result is a huge pile of rods, of exactly the same length, at the end of the day. Such a simple mechanism works day in and day out almost without attention. In the future, no doubt, radio servicemen may also have to include small factories among their customers for the inspection, maintenance and repair of such equipment.

### MOTOR CONTROL METHODS

Perhaps one of the most promising developments in the whole field of electronics, as it relates to industry, is the control of alternating and direct current motors through the use of rectifiers, thyratrons, etc. Any young radio serviceman who wants to assure himself of a profitable niche in the electronics business for years to come would do well to specialize in this branch of the business. It will pay handsome rewards.

Compared to what might have been expected a few years ago, electronic motor controls are today performing in a miraculous manner. Electronic devices used for this purpose not only make it possible to control such motors manually but automatically as well. They are started, stopped and accelerated with automatic electronic mechanisms. An example of the desirability of such control can be clearly seen in the matter of driving a planetary milling machine. Motors of such machines may be so regulated electronically that the cutting tool feeds into the work at a pre-determined speed. Not only this, but there can be automatic switching to another speed for a different operation and instant reversal of the motor at the end of the cycle. Manual controls are reduced to simple button-switches, located at the side of the machine. Only a moment or two is required to pre-determine and pre-set such a machine for any operating speed within the range of the motor.

Speed ranges for such equipment are limited by the motors used. Naturally overheating of the motors must be avoided, but soon we shall have special designed motors for such services. It is also rather obvious that D.C. motors are going to be more widely employed because they may be supplied with direct current from alternating current sources by electronic means.

The Ford Motor Company, like all automobile manufacturers, prides itself on accuracy carried to multi-split hairs. Johnson steel blocks lapped to an accuracy of

(Continued on page 434)

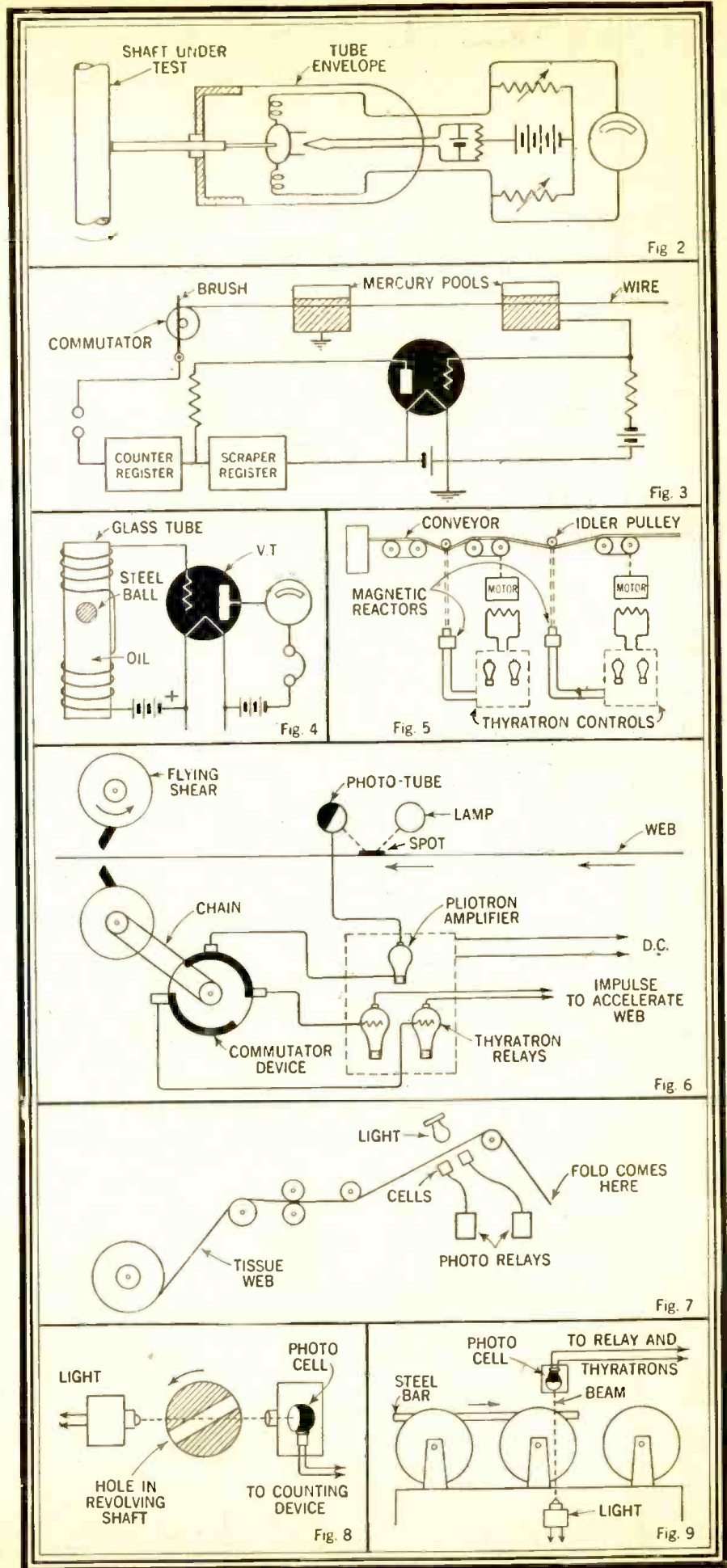

# Electron Age Coming

## Today's Applications Foreshadow Tomorrow's Developments

By E. M. ROBERTS\*

**W**ORLD War II has harnessed radio for the "walkie-talkie," the portable radio telephone which virtually eliminates the possibility of any more lost battalions; the "acoustic mine" which is set off by the sound of a ship's propellers; the "throat and lip microphones" used in tanks where the terrific din prevents ordinary communication; the "radio-marine automatic distress signal alarm" which pays no attention to ordinary code messages, but springs into action instantly to sound the alarm for a distress signal.

Civilian life also reveals the tremendous influence of new radio developments. Airplane parts can now be manufactured at greatly accelerated speed as a result of the process of surface hardening by radio frequency. Radio frequency generators shorten from hours to minutes the manufacture of plywoods and plastics. The electronic sewing machine welds a solid air- and water-tight seam. Paint baking is now 100 times faster, thanks to radio treatment. Two-way police radio now permits police cars to exchange information with headquarters and with each other *instantaneously*.

These are only a few of the accepted devices of today which, only yesterday, would have been considered miracles. Here

are a few wonders to come which are no longer in the "dream stage," but actually in process of experimentation:

Colors can be matched accurately between New York and San Francisco and other widely distant points through a telegram or radio facsimile message, thanks to the radio device known as the "spectro-photometer" which precisely charts color composition.

This amazing instrument has many other accomplishments including the ability to reveal the slightest traces of impurities in a given substance. For example, RCA technicians conducted the following experiment: Two cups of coffee were brought into the laboratory. Previously, one cup had been stirred with a silver spoon. The spectro-photometer readily identified which cup has been stirred by *detecting the minute particles of silver dissolved from the spoon.*

Improvements utilizing radio for safer driving are now in process of development. Tests indicate that soon there may be no need to peer out into the darkness, searching for red or green traffic lights. Instead, the driver of the future may hear in his car a reassuring musical tone as long as the green light is on. When the traffic signal flashes red, he will hear a high note implying "stop." Or, it may be that red and green lights on every car's dashboard will be operated by radio re-

lays tuned into the traffic system. (See "Traffic Lights in Your Car—By Radio" in *Radio-Craft* for December, 1938.)

The time is coming when lighting of school rooms, offices, shops and even many homes, will be automatically controlled by photo-cells to produce uniform high-intensity illumination, regardless of outside lighting conditions.

Successful tests have been made using radio waves to clear smoke and dust from skies over industrial centers. Further developments of this nature may ultimately permit cleansing the atmosphere of disease germs and other undesirable impurities.

New forms of ultra-violet lamp now sterilize the air about many operating rooms. This protection will soon be extended to the interiors of refrigerators, silverware, dishes in restaurants and the safeguarding of public health in many ways.

Inspection of finished steel can now be accomplished by the electric eye, which automatically throws aside faulty sheets. All types of selecting, sorting, eliminating, etc., are virtually assured future duties of this instrument.

Tests have been made of electric-eye controlled tools which make steel products direct from the blueprint, itself. Further developments are necessary before this can receive universal application.

J. O. Kleber, a chief engineer for American Foundation, has combined an electric eye with a buzzer so that as long as a blind person holds the "eye" in a guiding light beam, the buzzer sounds a reassuring note. Provided with a series of focused light beams in corridors, rooms and stairs, blind people can move safely and rapidly along, guided only by the electric eye.

An interesting new electric-eye development which is destined in the future for wide public acceptance, is the "automatic exposure meter." This device makes it unnecessary for camera owners to determine the proper exposure for a clear picture *before* pressing the button. The electric eye *automatically* will give the right exposure time or "stop" opening for a perfect picture.

An electric eye can watch the pilot flame in an oil burner and if the flame goes out, it will shut off the oil supply and ring an alarm.

Dr. Rentschler of Westinghouse advises that an electric eye can warn us about exposure to sunburn and when to get under cover.

The electric eye can detect an iceberg through the densest fog.

All these amazing services are still merely first developments for the electric eye and it is safe to predict that much wider uses will be found for it in the near future.

And radio promises many additional wonders to come:

Thanks to radio, newspaper half-tones may someday be engraved right off the long distance wire, from photographs actually 3,000 miles distant. These engravings will

(Continued on page 442)

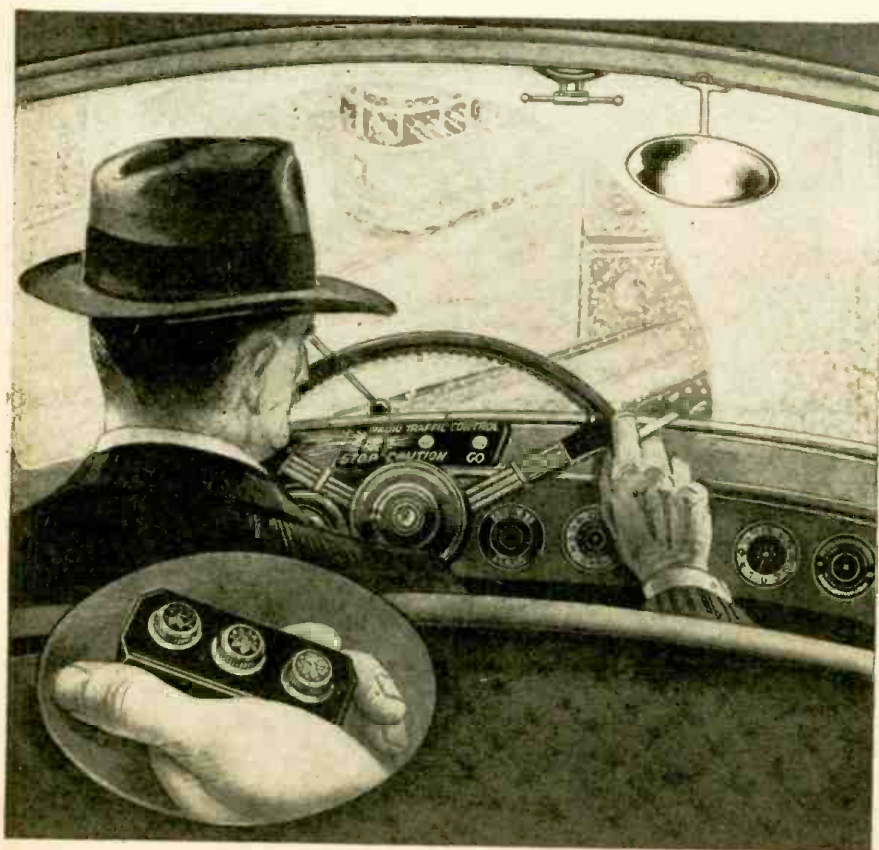

This apparatus was actually installed as an experiment, and worked successfully in 1938.

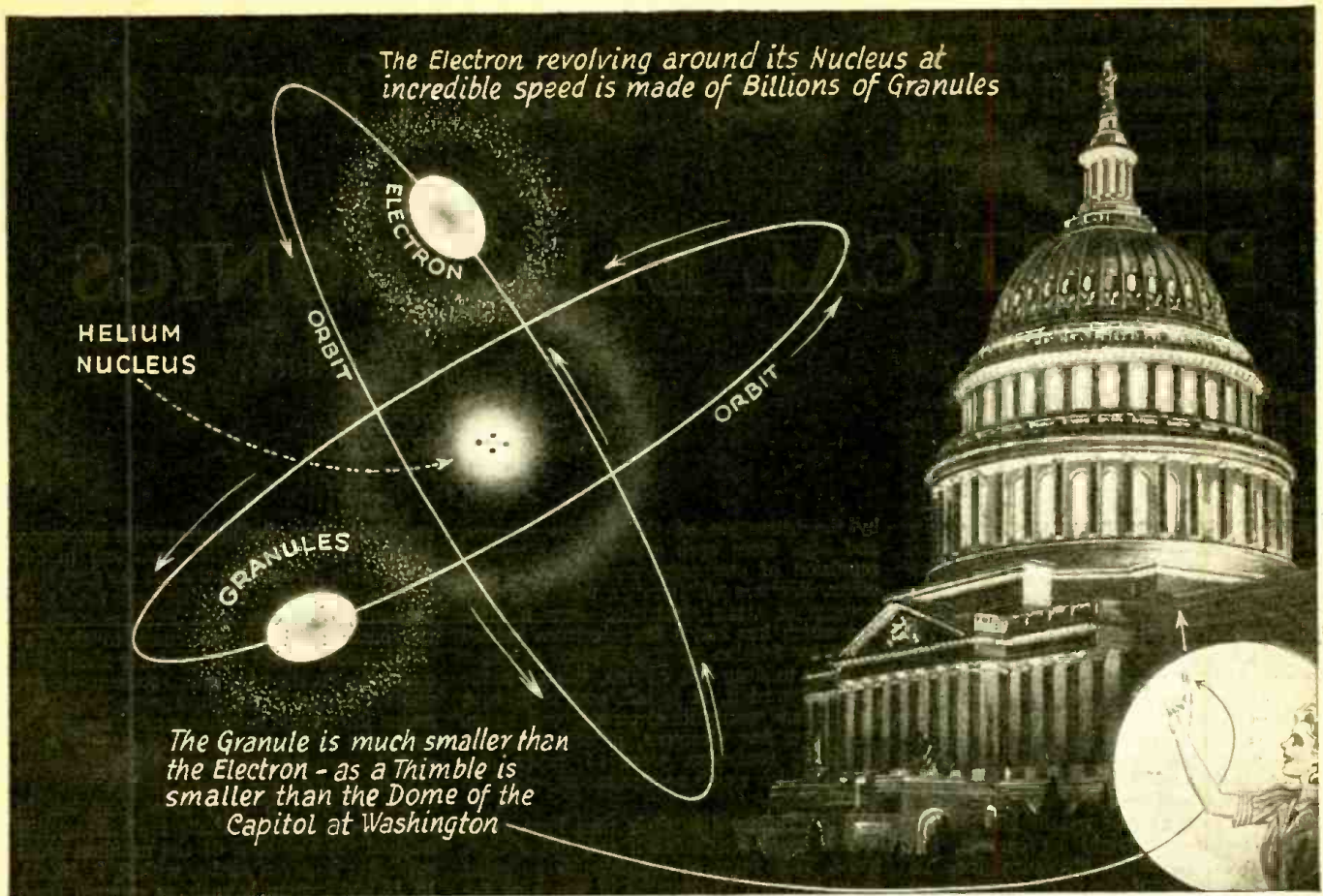

Existence of sub-electronic particles has long been suspected, and their discovery may open another world to our atomic explorers.

# The Enormous Electron

THE science of physics, which successfully maintained the *atom* for so many years—against all opposition—as the world's smallest entity, was forced from its position, and today would not even insist that the electron is the infinite in smallness. Official science has been reduced to a position where an atom, comparatively speaking, may be as big as the State of Texas.

More than ten years ago, Sir Joseph J. Thompson, the pioneer scientist who originally hunted the electron to its lair, declared his belief that space might be permeated with "granules" the substance of which make up the aggregates of matter and of electricity.

These particles must be indeed small if, as Sir Joseph believed, they are at least 3,300,000,000 times smaller than the nimble electrons. The artist has pictured, above, the dome of the Capitol at Washington, and a thimble held up against it. The discrepancy in cubic contents is even less than one of three billion.

The atoms of hydrogen, scientists now tell us, after viewing a few photographic scratches, are so small that a hundred million of them, if they ever became tired, could sit down side by side in a single inch.

Yet each atom of hydrogen is supposed to be an Earth-Moon system, in which a tiny moon (the electron) is revolving millions of times a second around an almost

*"There once was a tiny electron, who looked all about him and cried:  
"What an infinite thing is an atom! How long and how deep and how wide!"*

invisible Earth—the nucleus, 1800 times as heavy as the electron, but smaller in bulk.

However, the more the atom-electron theory was refined, the more unsatisfactory it became to explain, for instance, the peculiar actions of matter in presence of light. Instead of acting like a dignified moon, the electron is continually skipping around from orbit to orbit. It changes by fits and jerks. Evidently some other force, too small to be perceived by our instruments (which can just about see the shock of a violently propelled electron against the matter it strikes), is acting in infratomic space. It will be remembered that a similar agitation of small particles of matter, (the so-called Brownian movement) helped to establish the atomic theory of matter.

This is one of the reasons why the father of the electron expressed as the conviction of years' study that, compared to the particles beneath them in size, electrons are gigantic.

"We have no right whatever to maintain doggedly that we have reached the ultimate in infinitesimal material systems

when we deal with these familiar material units. Experience should quickly teach us how unsafe such an assumption would be," says Professor Harlow Shapley, the astronomer in *Flights from Chaos*. "But, in a hypothetical sub-electronic world, where there may be systems within systems indefinitely, our course-grained tools no longer bring information to our coarse-grained minds. It may be that we are stopped in our explorations downward, not because the limit is reached but because of our inherent awkwardness."

Perhaps it is true that the "granule," so infinitesimally smaller than the atom, is itself a cosmic system of inconceivable complexity; as the entire "cosmos" we see may be a single breath exhaled by an extracosmic being. It is quite probable that the "granule" may be established as a fact, by reasoning; though far too small ever to manifest its individual presence upon any instrument which man can devise.

It is not impossible to surmise, even though Sir Joseph is not quoted so far, that these granules may take the place of the hypothetical ether as the medium through which are translated electromagnetic impulses which we call light and its allied phenomena. If this be the case, and we are to assume that they act as does a gas, their motion is even swifter than that of light, set up by their "rarefaction" and "condensation."

Beginning with the fundamental electron, this course discusses electric phenomena as a result of electron activity. This may be a welcome innovation to students who have had difficulties with traditional presentations.

# A Short Course in

# PRACTICAL ELECTRONICS

## LESSON I—THE ELECTRON

By FRED SHUNAMAN

**T**HE electron—that infinitesimal, invisible particle of pure electricity—the basis of all matter—is logically enough the starting point of any study of electronics. Our grasp of all electric circuits will be remarkably simplified by looking at them as the result of such activity of electrons. Electricity and Radio studied from the electronic viewpoint become reasonable and easy to understand.

What is the electron? We are informed that it is the smallest particle of matter (so far accepted). According to another definition, it is the "unit charge of negative electricity." Neither of these definitions describes the electron, though they might lead us to suspect correctly that there must be a close connection between matter and electricity. It is as if we were told that Joseph Doakes is a Presbyterian, and in another definition that he weighs 150 pounds. Both descriptions might be correct, but would not help us to recognize Joe. To find out more about the electron, we must dig into the structure of matter itself.

Scientists have convinced themselves—by methods extremely interesting but impossible to describe in this space—that all matter is composed exclusively of positively charged protons and negative electrons. (It would be a mistake to say "negatively charged" electrons. An electron is a negative charge—a small piece of negative electricity.) This statement is over-simplified, leaving out such bodies as the recently discovered positrons and neutrons, but is sufficiently accurate for the purposes of our study.

### ELECTRON AND PROTON

According to this view, each of the atoms of which all matter is composed consists of a central nucleus made up of one or a number of positive protons (with a few electrons bound tightly into the mass) around which revolve one or a number of electrons, much in the manner of the Earth around the Sun.

Indeed, the Earth revolving around the Sun is a fair picture. It describes something of the spaciousness of solid substance. For the most astounding thing about matter is its very lack of matter. The most solid substance known is far more than 99.9% nothingness. If we were to take an ordinary copper cent—to use an ancient illustration—and expand it to 100 million miles in diameter, increasing its thickness at the same rate, we would be able to see those atoms and electrons of which we speak. The nucleus of the atom of copper, thus magnified, might be a little larger than a baseball. Each of these atom centers in our enlarged cent, would be more than a mile from its nearest neighbor, the center of a sphere a mile in diameter. This whole area would contain only 29 electrons, revolving in various orbits around the nucleus. An explorer in this copper universe would view a scene like that of Fig. 1.

These 29 electrons are held in their places

by the attraction of the positive nucleus, and kept from each other by the mutual repulsion of one negative charge for another. We are all familiar with the phenomena of static electricity—how a glass rod which has had a few electrons rubbed off it by friction against a piece of paper will try to drag bits of lint, silk or tissue paper toward it. It is left with a positive charge, and wants its electrons back again. To get a few electrons, it will drag the relatively enormous piece of paper distances which much appear astronomical to the electron.

The atoms are in their turn kept apart by the repulsion between the flying electrons. This force of repulsion is so great as to be hard to describe in terms of the ordinary forces to which we are accustomed in daily life. It has been calculated that if  $2\frac{1}{2}$  pounds of electrons were located at the North Pole and an equal quantity at the South Pole of the Earth, they would repel each other with a force of 200,000,000,000,000 tons! With forces like that inside it, it is not surprising that the copper penny does not collapse into itself.

If the nuclei were illuminated, the scene might well look like the heavens on a starry night. We would even have a Milky Way, because of the disc-shape of the coin. Hence the fantastic concept that our own universe, Milky Way and all, may be "a nickel in some giant's pocket."

Seriously, this openness and emptiness of matter is very important. It gives the electron a chance to get around. When bound to its nucleus by electric attraction, it is a part of electrically neutral matter. But if some way is devised to get it moving on its own, it becomes electron flow or current, and temporarily seems to be something altogether different from matter.

How the electron may be persuaded to start out independently is also bound up with the way atoms are constructed. Though all atoms are composed of protons and electrons, there are no less than 92 primary varieties of them, the 92 elements from which all substances on earth are made. The electrons in all these 92 varieties are exactly alike, but the number varies from 1—in hydrogen, the smallest and lightest atom of all—to 92 in the atom of uranium. (Besides its 92 planetary electrons, revolving outside the nucleus, uranium has an additional 146 packed inside, the whole balancing the 238 protons it contains.)

These planetary electrons revolve around the nucleus in well-defined orbits, called shells. No more than two electrons are found in the inner shell. Helium is the atom with 2 electrons, and is the second lightest thing in the world. Next up in the

scale is lithium, the lightest solid substance. It also has its two electrons, and in another orbit far outside that of the first two, a third one. As we go on through the list of elements, each one adds another atom to the outer shell till we come to the familiar neon, which has an outer shell of 8 electrons. At the next atom, sodium, we get another break. The 8-atom second shell remains intact, and another lonely electron is away out in space, trying to start a third one. Apparently not more than 8 electrons can crowd into the second shell.

As elements become more complex in structure, successive shells are built up, till we find the electrons of the uranium atom revolving in seven shells, with 2, 8, 18, 32, 18, 13 and 1 atom in each, as counted from the inner one.

The outer shell of an atom decides its chemical or electrical disposition. Peculiar among all the elements are those contented atoms with full outer shells. Helium has long been known to be the ideal gas for dirigibles, because it will combine with no other element. Unlike hydrogen, which is always searching for another substance to fill the empty place in its outer shell, and combines furiously with the oxygen in the air on the least provocation, helium cannot be burned or otherwise affected chemically.

Atoms with incomplete outer shells tend to be more sociable, combining with others which will help them fill the vacant outer spots in their envelopes. Fluorine, only one electron short of the eight needed for a complete outer shell, is such an inveterate joiner that it long escaped discovery. It combined immediately with the glass in the chemists' vessels, and was never to be found in the substances being investigated!

Even more interesting are those atoms with only one or a few electron in outer shell. The lonely electrons, whose bond to the nucleus is comparatively weak, may be knocked loose from its parent atom by collision with another electron, or by other means. We then have a free electron. The atom, now short one electron, becomes a positive ion. If some means can be found to knock the outside electrons off a great many atoms and impel them in a certain direction through an element, we have an electron flow or electric current.

Elements (or compound substances) through which electrons can flow easily are conductors of electricity. Silver, the best of all conductors, and copper, the structure of which is shown on the opposite page, most commonly used to carry electricity, both belong to the group of elements which have one electron in the outer shell, as does gold, another excellent conductor.

(Continued on page 436)



Fig. 1



HOW THE MACROCOSMIC COPPER CENT WOULD LOOK TO A WANDERER FROM THE OUTSIDE WORLD

Fig. 2

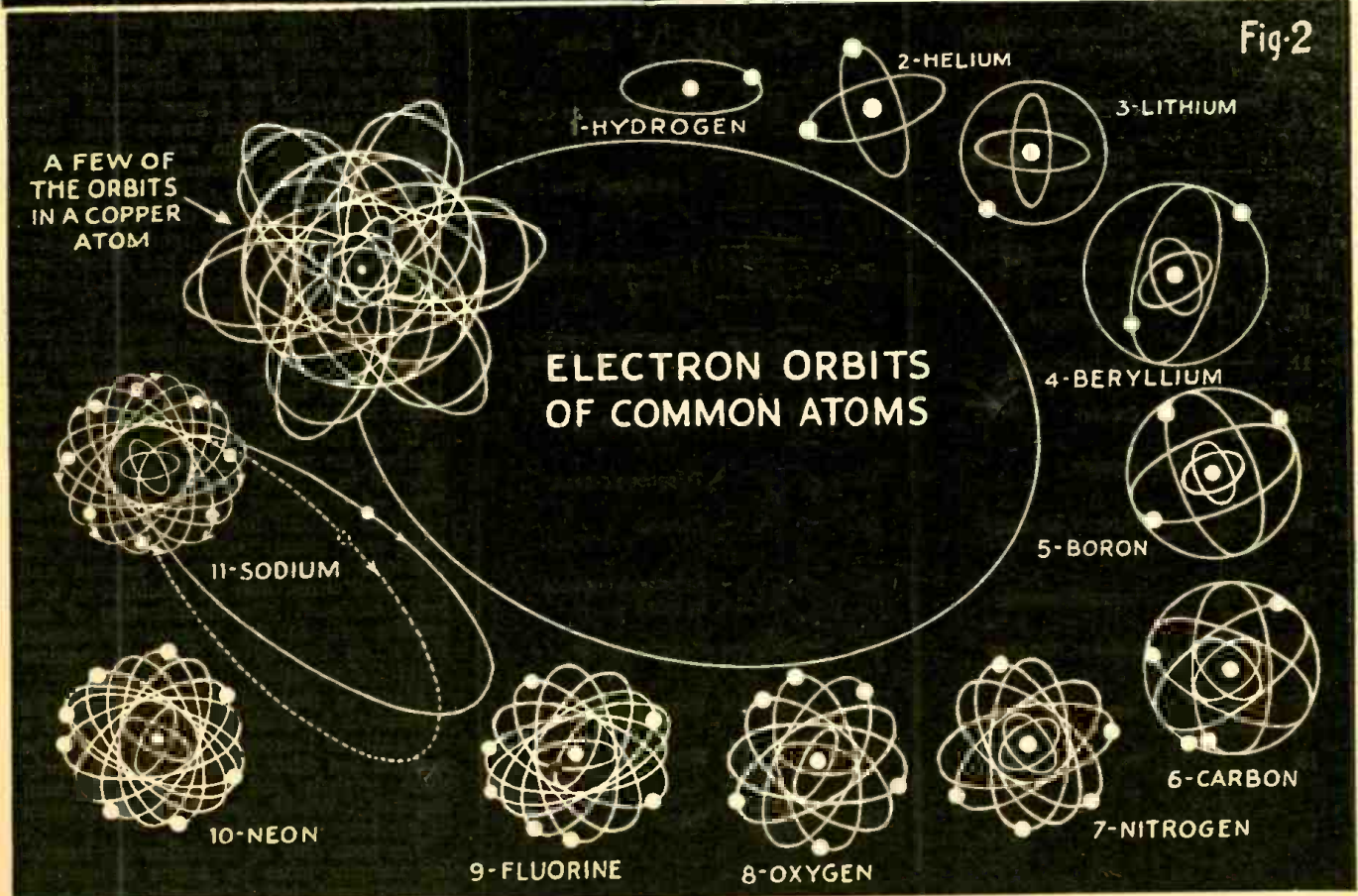

Fig. 2—Electron shells of atoms from hydrogen to sodium, also copper. The long orbits are the "wild" electrons of copper and sodium.  
RADIO-CRAFT for APRIL, 1944



# ELECTRONIC DIAGRAMS

By CARL H. WINTER

**M**ANY technicians who so blythely answered "yes" to the question "Can you read blueprints?" upon going to work in radio manufacturing war plants, are learning to their dismay that they cannot properly read a radio circuit schematic.

There is a very good reason for this. During peace years the average radio amateur or serviceman, and many engineers as well, were able to interpret schematics readily—because they were familiar with the circuits. Now, under the press of new designs, new components, and new applications, they are lagging behind because

they fail to recognize the slight symbol variations which specify more exactly the components the symbols represent.

Many engineers and technicians have forgotten the basic principles of radio circuit drafting. The symbol  may indicate a condenser, but what if it were  or ?

Multiply these variations by the many basic radio graphic symbols; consider the use of symbol designation letter prefixes and numerals. Can you always understand the indicating callouts on photographs and installation drawings? In short, ask your-

self, "Can I properly interpret radio circuit schematics?"

The development of radio circuit drawings, more generally known as schematics, is a direct offshoot of the science of technical drawing. As most people with a technical turn of mind realize, such drawing is the medium whereby engineers develop and record their ideas. As all radio engineers use the same method of symbolism and the same type of schematic drawing to record plans, one technician has no difficulty in carrying out another's design.

To the understanding observer, a schematic will show, not only all the components used and the manner in which they are inter-connected, but the type of component as well, and, through the use of callouts and symbol designation numerals which are used in most cases in conjunction with parts lists, all the additional information required to build the unit illustrated by the drawing. Thus, a technician can proceed to his work with a minimum of time wasted by reference to catalogues and tables.

Two primary requisites in obtaining this understanding are a knowledge of the radio graphic symbols used by draftsmen to designate the components indicated in a circuit design, and an understanding of how symbol designation numerals and prefix letters are chosen to indicate specific components.

Radio graphic symbols commonly accepted by radio engineers are shown in Table 1. Note that the length, thickness and shape of a line can change the meaning of a symbol to a great extent. These are the details which are so often overlooked by people who are, unfortunately, too familiar with schematics.

For example, refer to Table 1 and note the similarity between the symbol for a fixed condenser and the symbol for a battery. A too rapid glance, and fifteen minutes may be wasted in trying to identify the component in a parts list.

The shielded condenser symbol is easily confused with the symbol for a crystal or piezo-electric plate. A counterpoise can be mistaken for an antenna if the schematic is looked at from the wrong angle.

Unless the symbols for meters are clearly marked, the wrong type of meter may be inserted in a "hot" line and an expensive piece of equipment ruined. The crossing of wires without having adjacent connections very clearly indicated to show the symbolic contrast between crossed and connected wires, may be troublesome to a hasty engineer. The identification of the moving coil in the transformer symbol shown on line 30 of Table 1 requires careful observation.







































Many of these simple time destroying errors can be avoided if the reader of a schematic is thoroughly familiar with the symbols and other markings in use. Study these symbols and refresh your mind constantly. We all tend to become careless as we become confident.

The possibility of confusion in identifying vacuum tubes by means of symbols is very great, but fortunately, most sche-

(Continued on page 438)

Table 1

## RADIO SYMBOLS

1. 	Antenna	20. 	Lightning arrester
2. 	Antenna, loop	21. 	Loud speaker
3. 	Arc	22. 	Meter
4. 	Battery. Longer line indicates positive electrode	23. 	Microphone, telephone transmitter
5. 	Capacitor, (condenser) fixed	24. 	Phototube
6. 	Condenser, shielded and fixed	25. 	Piezo-electric plate
7. 	Condenser, variable	26. 	Switch
8. 	Condenser, variable with moving plate indicated	27. 	Transformer, air core
9. 	Condenser, variable and shielded	28. 	Transformer, iron core
10. 	Counterpoise	29. 	Transformer, variable coupling
11. 	Crystal detector	30. 	Transformer, variable coupling with moving coil indicated
12. 	Ground	31. 	Thermoelement
13. 	Inductor	32. 	Telephone receiver
14. 	Inductor, adjustable by steps	33. 	Resistor
15. 	Inductor, variable	34. 	Resistor, adjustable by steps
16. 	Inductor, iron core	35. 	Resistor, variable
17. 	Jack	36. 	Wires joined
18. 	Key	37. 	Wires crossed
19. 	Lamp	38. 	Tubes

Mr. Powell, well-known to RADIO-CRAFT readers through his articles on audio subjects, will in this series discuss audio distortion from a broader viewpoint than usual in such articles. Not only will the usual types and causes of distortion be considered, but also such features as acoustic and biological effects, which are independent of the amplifying apparatus, and are not usually considered under the head of audio distortion.

# AUDIO DISTORTION

## PART I—CLASSIFICATION, HARMONIC DISTORTION

By TED POWELL\*

**T**HIS paper is a *non-mathematical* discussion of the various types of audio distortion effects now known to exist. Some new types of distortion have been uncovered in the past few years. These discoveries have somewhat changed the modern sound technician's approach to the distortion problem in audio equipment. It is becoming increasingly obvious that newer and more adequate distortion rating standards will have to be set up in the near future in order to take these newer developments into consideration. This is especially true in the case of intermodulation distortion.

### CLASSES OF DISTORTION

Eight distinct types of audio distortion will be listed here, of which six are definitely known to exist, one is suggested by the writer and the other takes into account acoustic sources of audio distortion. They might be defined as follows:

1. **HARMONIC DISTORTION**—Also known as Amplitude Distortion or Non-Linear Amplification Distortion. This type of distortion is caused by the addition of spurious harmonics or sub-harmonics to signal frequencies passing through a non-linear network.

2. **INTERMODULATION DISTORTION**—Also known as Interference Frequency Distortion, Cross-Modulation Distortion, Sum-and-Difference Frequency Distortion or Harmonic Cross-Modulation Distortion. This type of distortion is caused by the addition of spurious sum-and-difference frequencies to complex frequency signals passing through a non-linear network.

3. **FREQUENCY DISTORTION**—Also known as Frequency Discrimination Distortion. This type of distortion is caused by the unequal amplification of the various frequency signals passing through a non-linear network.

4. **PHASE-SHIFT DISTORTION**—Also known as Phase-Delay Distortion, Phase-Displacement Distortion, Delay Distortion or Velocity Distortion. This type of distortion is caused by the alteration of the phase-angle relationships of the various signal frequencies passing through a network.

5. **FREQUENCY-MODULATION DISTORTION**—Also known as "wow" and "hash" in recording work. This type of audio distortion is caused by the cyclic variation of higher audio frequencies by lower audio frequencies (or by low-frequency varying circuit constants) which are passing

through a network or an electro-mechanical transducer.

6. **FREQUENCY-SHIFT DISTORTION**—This type of audio distortion is produced when the signal frequencies passing through an electrical network are shifted by a fixed frequency sum or difference or multiple.

7. **DYNAMIC DISTORTION**—Might also be called "Volume Distortion." This is a minor theoretical audio distortion effect suggested by the writer. It may be a non-linear signal-amplitude-vs.-time distortion effect, especially in the case of transient steep wave-front signals passing through a network.

8. **ACOUSTIC DISTORTION**—This type of distortion is purely mechanical and is caused by various acoustic types of audio distortion which occur at the microphone and speaker ends of a communications system, some of which are peculiar to acoustics and some of which are mechanical counterparts of electrical circuit distortion effects.

### NON-MATHEMATICAL ANALYSIS

**HARMONIC DISTORTION**—This distortion is caused by various circuit non-linearity effects such as curved amplifier tube characteristics, overloaded amplifier tubes, poor amplifier tube electrode voltage supply regulation, improper amplifier tube bias and electrode voltage supplies, overloaded magnetic-core components, non-linear gap-flux vs. amplitude-swing characteristic of electro-mechanical transducer units and non-linear amplification effects of audio transformers.

This type of audio distortion is closely tied up with frequency and intermodulation distortion when complex-frequency signals are involved. Where simple single-frequency signals are being passed and the harmonic distortion is excessive, the distortion might be detected by the ear as a change in quality, especially where odd-order frequencies and odd-order harmonic distortion is involved.

When complex frequencies are being passed, intermodulation and other distortion effects enter into the picture and the distortion problem becomes rather complex, especially when non-harmonically related odd-order frequencies are being passed. The "sourness" and "tinniness" evident when signals are being distorted by an audio system, is to a considerable degree due to the harmonic distortion effects of the system.

It must be emphasized here, however, that harmonic distortion has long held the spotlight in audio work to a degree out of all proportion to its true significance where total audio distortion generated by any network is concerned. Modern sound

technicians now disregard harmonic distortion ratings as being misleading and gage the performance of audio equipment by much more effective and dependable standards today. (Intermodulation frequency and square-wave generator analysis.)

**INTERMODULATION DISTORTION**—This relatively little-known audio distortion effect, oddly enough, has been recognized since the days of radio's infancy. It was known as "sum-and-difference" frequency distortion and was classed under harmonic distortion. At regular intervals some experimenter or sound man would "discover" this distortion effect and call it "cross-modulation" or "interference frequency" distortion or some similar title.

Strictly speaking, intermodulation is the sum-and-difference frequency generation effect caused by the inter-action of signal frequencies passing through a non-linear network, while cross-modulation is the impression of one carrier frequency's signal modulation frequencies upon another carrier frequency. However, the writer has heard top-notch radio engineers refer to intermodulation distortion as cross-modulation distortion.

The strange part of the history of this poorly understood distortion effect is that after all these years, its true significance and serious effects upon audio system performance have just begun to be recognized.

### INTERMODULATION DISTORTION

If a single sine-wave signal of a few hundred cycles be fed into an ordinary amplifier and the amplifier output be checked with some sort of frequency analyzer, it may be found that harmonic distortion of the sine-wave output might be about 2½% at full rated amplifier output. If another sine-wave signal of less than 100 cycles be sent through, the spurious harmonic content might be found to be about 4%. If now both signals be sent through the amplifier simultaneously, the total distortion generated may suddenly jump up to a total as high as 13%. Obviously, something other than simple harmonic distortion has now entered into the picture.

If the amplifier output be tied up to complex frequency analyzer equipment, it will be found that the amplifier not only is putting out the two fundamental frequencies and their even and odd-order harmonics but also an elaborate array of sum-and-difference frequencies as well.

This intermodulation effect is particularly serious in the case of odd-order frequencies odd-harmonically distorted. In such cases the resultant harmonic and in-

(Continued on page 433)

\* Naval Electrician—Ship Repair Force—(Associate I.R.E.)

This is the first of a series of three articles on audio distortion. The second will appear in next month's issue.

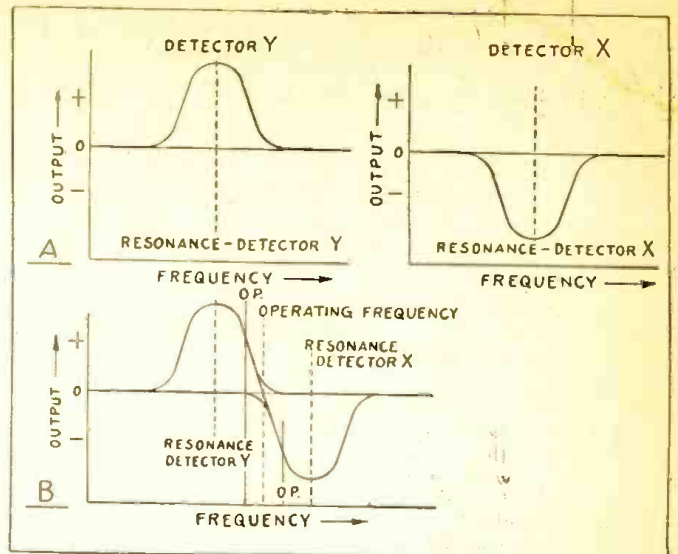
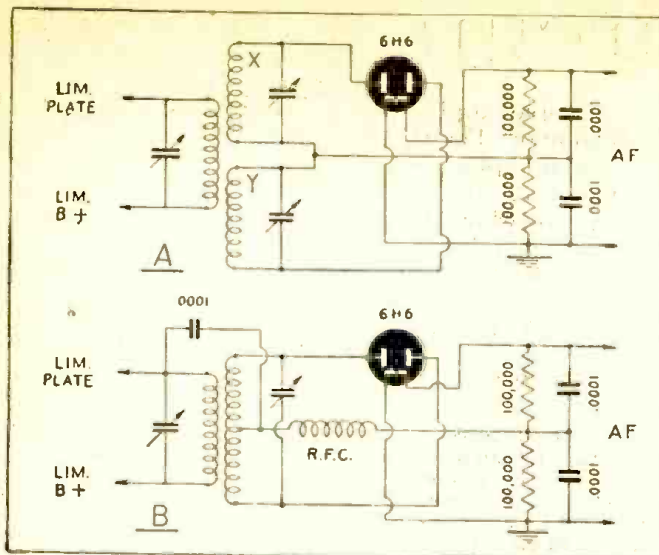

Fig. 1, left—Two fundamental FM discriminator circuits. The system at B is the one now commonly used in commercial FM receivers. Fig. 2, right—How the two separate AM detectors of Fig. 1-A can be made to operate as a discriminator for detecting FM signals.

# TWO-TUBE FM RECEIVER

A SIMPLIFIED CIRCUIT FOR WERS OR EXPERIMENTAL USE

**T**HE receiver is usually not only the weakest link in an FM set. It is also the trickiest piece of equipment to construct, and completely out of the range of the average experimenter's facilities in these days, unless some means of getting around the use of the big FM superheterodyne is found. The receiver about to be described is not a time-tried circuit such as the transmitter design outlined in last month's article. Reception of FM signals has been satisfactory on a set of this design, but there is plenty of room for refinement, improvement, and such general puttering around as the ham experimenter loves before a really reliable set will emerge. The circuit details are given here merely as a jumping-off point for the amateur.

In attempting to get around the use of the big FM super, let us see just what we are up against. The U.H.F. ham working with AM gets around it by falling back on the time-tried super-regenerative detector, self-quenched or otherwise as the case may be. What relation do these two types of receivers bear to each other? If we analyze the superhet, we find that basically it is built around a diode or triode detector ignominiously shoved away unnoticed under the title of "second detector stage." The rest of the tubes, while placing the greatest drain on the amateur pocket and causing him to consume much headache powder, are actually nothing but devices to increase the selectivity and boost the signal a bit. These are very laudable ambitions, but we find that if we just turn the second detector into a triode (if it isn't one already) and add the simple, well-known super-regenerative connection, all the complicated R.F. and I.F. systems may be calmly pushed aside, and we still have a receiver of very passable gain and enough selectivity to get by on.

Now to apply our findings to FM equipment. Going inside the FM superhet, we notice that the meek little second detector has grown until it is graced by the impressive name of discriminator-detector and even has a subordinate—the limiter tube—to help it.

By DEAN S. EDMONDS

This last stage may be omitted with a corresponding reduction in the receiver's ability to cut out interference, but even then the problem of converting the discriminator to a circuit which can stand alone as a receiver without the preceding R.F.-I.F. system is a serious one. First let us look at the circuits used in modern discriminator-detector systems. The two almost universal ones are shown in Fig. 1.

The circuit of Fig. 1B depends for its operation on a series of phase relationships and resulting voltages in different parts of the circuit. It is therefore very difficult to adapt to any kind of regenerating system such as must be used to get a satisfactory single-tube receiver on the U.H.F. The circuit of Fig. 1A, however, operates on a very simple principle and therefore (in spite of the fact that its more complicated coil construction has caused it to become less and less popular as a second detector in FM superhets) affords the experimenter the opportunity he needs.

If we study this circuit for a bit we find that it really consists of two ordinary AM diode half-wave detectors. Each detector uses one diode unit of the 6H6 in conjunction with the respective tuned circuit *x* or *y* and the respective 100,000-ohm load resistor.

These two diode detectors are driven from the same source and have their outputs connected in reverse series—that is, the two detectors are interconnected in such a way that their outputs are in series, but in series so that the two outputs oppose each other and tend to cancel instead of helping each other. Now let us make some curves by plotting input frequency against output voltage on each diode separately and then on the whole system. These curves are shown in Fig. 2.

In Fig. 2A are shown the curves of each half wave detector operating alone. A regular selectivity curve appears in each case,

the only difference being that one is positive and the other is negative. This is because one rectifier uses as the "low" side of its output the opposite side from the one used by the other rectifier. Now let us drive both detectors from the same source and tune one so that its resonant frequency approaches that of the other until the two curves just barely overlap. We have the output curve of Fig. 2B, for the complete system. The slight overlap of the two waves is used to straighten out the curved portion at the base of the waves by cancellation so that the wave will be as near a straight line as possible between points OP-OP.

It will now be noted that the section of the curve between these points is in the form of a good discriminator characteristic. If an FM transmitter is now tuned so that its resting (unmodulated) frequency is that marked "operating frequency" in Fig. 2B and then frequency-modulated so that the sweep lies between the limits OP-OP, the discriminator-detector will give out the modulating signal with a very high degree of fidelity.

Now that we have seen the operation of this circuit, let us return to the fundamental elements of the system. These, we found, were two AM half-wave diode detectors driven from the same R.F. source and having their outputs connected in reverse series. So we see that essentially our system consists of two AM detectors. And that gives us just what we want. It is now possible to substitute a couple of triode super-regenerative circuits for the diode detectors we have hitherto been talking about, connect their outputs in the same way and couple their tuned circuits to the same antenna. Then we have a receiver with the sensitivity of an ordinary AM superregenerative and incorporating the frequency discriminating characteristic necessary for proper reception of FM signals. Using each triode unit of a double triode tube such as the 6F8-G as a superregenerator,

(Continued on page 431)



# Calibrating Generators

By JACK KING

**T**HE Serviceman today may find himself compelled to construct a shop signal generator for himself, or to bring back into use an old and discarded commercial generator which is no longer even approximately accurate. Neither of these operations is especially difficult, if intelligently and carefully carried out.

The calibration of the commercial generator presents a problem somewhat different from the calibration of a shop-built one. Usually, the commercial instrument is already calibrated, but not to hair-line accuracy. One reason is that changes in the spacing of parts or wires in shipment may occur, another that precision calibra-

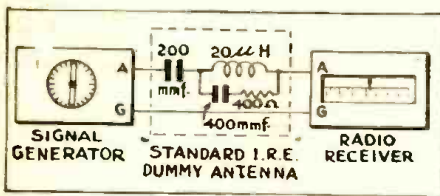

Fig. 1—A receiver is used for calibration.

tion in mass production is not feasible and that the cost would be prohibitive (except in the case of laboratory instruments where cost is secondary to high accuracy). The home-made generator must usually be calibrated "from scratch." The accuracy of any of these instruments will depend to some extent on the readability of the dial and the constancy of the dial setting. Therefore, in building an instrument, it is important to choose a dial which is rugged and which can be closely read with freedom from errors of parallax. The dial should be checked and it should be certain that there are no loose set screws or slip-page of any kind. Otherwise, errors in frequency measurements will be introduced, nullifying the results of painstaking work in calibrating the instrument.

The generator may be calibrated in a number of ways. Using only a single generator and the regular broadcast stations in conjunction with a good receiver, a fairly accurate job can be turned out. Let us assume that we have a radio receiver which is perfectly calibrated and has had corrections applied so that its accuracy is just about as good as we can possibly make it. To calibrate the generator, we may then tune in signals on the receiver and identify the signal frequencies from the receiver dial calibration.

To avoid picking up harmonics of the generator fundamental frequency, the receiver is tuned to the lowest frequency that it is expected the generator will put out. It is assumed the receiver has adequate pre-selection before the 1st detector. The condenser plates of the generator may be set at full mesh so that it will produce its lowest output frequency. The test set-up is that of Fig. 1. A standard Institute of Radio Engineers antenna is used between the generator and the receiver.

This hookup is useful for checking the output of the generator at broadcast band frequencies or on short wave, but is not very good for checking extremely low frequencies so far as tuning to the fundamental is concerned. A frequency of 100 Kc., for example, would be well below the I.F. value of the average superheterodyne. Sup-

pose we expect that the generator will put out a frequency no lower than 600 Kc. The generator dial is set at 700 Kc. Tuning the receiver dial from 600 to 700, we may find that we get a response at 698. This is a difference of 2 Kc. and we may write generator dial 700 gives an output of 698, error equals -2. We can make a similar series of checks over the band from 600 to 1700, or whatever band we may happen to be working on, using the same principles. The collected data may then be used to work up a new calibration curve.

If desired, there is another way of going about it. Suppose that we want to find the dial setting of the generator for an output frequency of 600 Kc. We may simply set the receiver at 600 Kc. and tune the generator above and below 600 Kc., within a range of 20 or 30 Kc. (since no commercial generator will be extremely inaccurate), and in that way find the generator dial setting for the 600 Kc. output.

There is still another and even better way in which we could do the job. In this method, the receiver need only be calibrated approximately. Of course, the higher the accuracy of the dial calibration of the receiver, the better—but the real standard will be a signal of known frequency, which may come from a broadcast station, standard frequency station, or a standard laboratory generator. The test set-up is shown in Fig. 2. We may dispense with the dummy antennas as they are not vitally important in frequency measurements. The unknown frequency is that of generator "A" which is the generator to be calibrated. The known frequency is that of generator "B" which is the standard of comparison.

## THE BEAT-FREQUENCY SYSTEM

First, the station or signal of known frequency is tuned in on the receiver. The output level of the signal is adjusted, if from a standard generator, so that it is at a low level. If an antenna is used, the input level should be kept at a low value by using a short antenna or by connecting a variable resistance of 10,000 ohms across the antenna and ground terminals of the set, adjusting the resistance to a lower value to cut the input level. In this way, the a.v.c. will not cause broad response.

The generator to be calibrated, "A," is now tuned to zero beat with the known signal. If, as an example, the generator is adjusted to 699 Kc. and the standard signal is 700, a 1 Kc. difference frequency will be produced, causing a 1000 cycle note to be heard in the output of the radio. As the generator is slowly tuned from 699 to 700, the pitch of the note and the difference frequency will decrease. At 699.5 the difference frequency will be 700-699.5 or .5 Kc. A zero beat, no audible sound, the two signals will be on exactly the same frequency. In making the adjustment it may be found that you overshoot the mark and it will be necessary to backtrack. Thus, at 701 Kc. we also get a 1 Kc. difference and a 1000 cycle audio note, since 1 Kc. is 1000 cycles and 701-700 equals 1 Kc. Many technicians use a rocking adjustment in finding the critical zero beat point.

In the above test, the standard generator or broadcast station frequency is the fixed value and the generator to be calibrated has its dial setting varied. Another way of doing the job—provided an accu-

rate source of frequency is available—is to tune the standard generator until it beats with the unknown frequency, and in that way identify the unknown. Suppose, for example, that the generator dial was set at 455 Kc. and we had a laboratory type generator on hand for calibrating purposes. The lab generator dial would be slowly swung about 455. We might find that a zero beat condition would be obtained with the lab generator at 456, showing the service generator had an error of 1 Kc. and was putting out 456 for a 455 setting.

## CALIBRATING THE RECEIVER

A calibrated receiver is a great help in frequency measurements. We may accurately calibrate the set by using a 100 Kc. crystal oscillator. Oscillators of this type have been made available to servicemen in recent years for just that purpose. It is also possible to do the job with an ordinary servicing generator by first getting it set accurately on 100 Kc. The setup of Fig. 2 would be used, the generator "B" being replaced by a broadcast station operating on some multiple of 100 Kc. Suppose, for example, we tune the receiver very accurately to 600 Kc. The receiver dial setting may read 601 or 602 Kc., but we know the station frequency is 600, since the program can be identified and reference made to a newspaper, or a station log can be consulted. Now the generator is adjusted to zero beat with the 600 Kc. station. If the generator is adjusted to 200 Kc., its third harmonic may beat with the station. In the case of a home-made generator we would continue tuning until the lowest dial setting was found that would produce the beat note. Then a further check would be made by holding the generator dial constant and varying the receiver dial, observing whether beat note responses are heard at dial settings which are multiples of 100 Kc. ap-

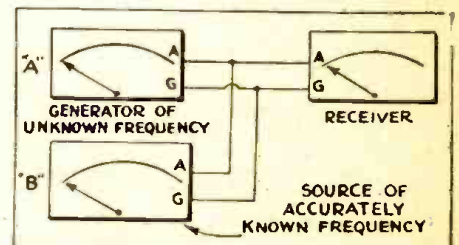

Fig. 2—The accurate beat-frequency method.

proximately. For example, a number of stations of known frequency will be operating on the band, and if it is found that the beat note is heard at 700, 800, 900, 1000 and 1100, the fundamental is 100 Kc. The fundamental frequency will equal the difference frequency between harmonic frequencies. Note the constant difference frequency in the above example, 100 Kc. from 600 to 700, 100 Kc. from 700 to 800, etc. If one of these—say 800 Kc.—is identified by a broadcast station at that point, a generator may be calibrated by carefully tuning receiver and generator to the other harmonics. In actual practice, the receiver would be sufficiently accurate as to prevent mistaking the 8th harmonic of the generator for the 7th or 9th, and the generator may easily be calibrated from one end of the band to the other by beating the generator signal with oscillator harmonics.

# Sally, the Service Maid

## The Case of the Silent Speaker

By NATE SILVERMAN

WIPING the perspiration from her face with a bruised, well-rounded forearm, Sally Mason looked at the Emerson table model radio in deep disgust. The darned thing had been much better, even with that old speaker. Even the torn speaker cone had reproduced speech and music with greater volume than the brand new speaker she had installed. For the hundredth—or was it the thousandth?—time she carefully checked all of the plate and screen grid voltages. Yes, the 35Z5 output was normal; all other voltages were low. But why?

She glanced at the new sign on the window of her radio shop: SALLY MASON, SERVICE MAID, it read.

"Service!" she said bitterly. A peculiar feeling suddenly crept over her. She never could explain its source. Was it the Strauss melodies coming from the radio receiver she had just repaired? Dad liked Strauss waltzes. Somehow, she always thought of Dad when she heard Strauss.

"Now, let's not get panicky, dear," she thought she heard Gus Mason's deep voice saying in his quiet manner. "There is no such thing as a radio being perfect—and not performing at peak efficiency. That old, old cry of despair: 'Everything tests perfect, only the radio ain't! Now let's calmly think it over. V-e-r-y c-a-l-m-l-y.'"

"Okay, Dad—" Sally rubbed her eyes. Was she dreaming?

But Dad was teaching radio to Signal Corps trainees a thousand miles from home, and Sally was on her own. A year in radio school and another in Dad's shop had taught her much theory. Dad, she recalled, had said something about "too much theory."

Still unable to completely overcome the weird feeling of awe, she tried to calmly survey the job at hand. A five-inch electrodynamic speaker, in spite of its badly torn cone—doubtless a loose voice coil as well—had performed better than the new five-inch electrodynamic speaker she had installed in its place.

True, the new speaker, in spite of lower volume, did sound better—less distorted—but the volume was gone. And no reception from the weaker stations she had heard on the old speaker. What could have gone wrong? At least a dozen times she had traced the four speaker leads. She had even made ohmmeter checks to make sure the color code was the same on both speakers. Yes, color code was the same.

And the field connections were correct: From 35Z5 cathode to 50L6 screen. Output transformer leads went to plate and screen of the 50L6. Of that much she was certain. And the new speaker, of a different make, fit perfectly in place. What could possibly be wrong?

"I—I beg your pardon, Miss. May I speak to the Radioman?"

Sally looked up at a solidly-built young man in uniform. The uniform, she decided, was all that had saved him from the tongue-lashing he so richly deserved. Didn't she have enough trouble already?

"I," she said coldly, "am the Radioman. There's a war, y' know."

He touched his corporal stripes on his sleeve and nodded.

"Oh, I'm sorry!" she said. "What can I do for you?"

"I'd like to buy a high-impedance Antenna Coil. Or, if you have the separate windings, the antenna winding, I'd like to buy that, please."

From the shelf she brought down the desired coil and he bought it.

"That T, under your Corporal stripes—Technical Corporal?"

"Bryner, Miss, Dan Bryner."

"Radio?"

"N-no, Ma'am. I used to be a Ham. But my regular work was in a garage. Automobile mechanic. I'm in the Armored Division. Fixin' Tanks," he said with a grin, "isn't so different from the work I've always done."

Sally pushed back the loose strands of dark brown hair which seemed determined to get into her eyes. "My Dad is an Instructor. Radio Instructor. And I'm doing my poor best to keep the shop running, until he's back. I wish he were here, to help me."

The Corporal glanced at the sign on the window and a slow smile did wonderful things, Sally thought, to his tanned young face.

"What seems to be the difficulty?" he asked.

Sally invited him to listen to the Emerson. For a while he tried to tune in various stations. Then he tested all of the voltages. Shaking his head he remarked: "Low voltages, everywhere except at the rectifier output. The 50L6 could be shorted."

He tested all of the tubes. "No; not in the tubes." With the set disconnected from the line, he used an ohmmeter to check for leaky condensers. Then he asked her to use the voltmeter. "See the large voltage-drop across your speaker field. Too high!"

She made the reading. "But how do you know? I have no schematic on this set; don't even know the model number."

He grinned. "You don't have to. We have nearly 120 volts coming out of our rectifier. That is what is going into the speaker field. By the time it comes out of the speaker field, our voltage is low. As we have no shorts of any kind, isn't it obvious that our field is to blame?"

The speaker is perfect . . . yet, it isn't! It will do you more good, if you, not I, find the rest of the trouble."

Sally carefully examined the speaker, paying particular attention to the field. That is where the Corporal had said the trouble lay. She sadly shook her head. "I don't see it."

"Here—check the old speaker," he said gently. "And, please . . . let's do it v-e-r-y c-a-l-m-l-y."

Sally was startled; so very much the way Dad talked!

"Just a hint—check all of the speaker resistances. Check and compare the ohmic values—resistance in ohms—of both output transformers and both fields."

In a few moments Sally exclaimed: "Why, the old speaker field reads about 450 ohms; the new one is 3,000 ohms!"

Dan smiled at her. "That's it!"

"But why? Why should it make so very much difference?"

He scratched his blond mop of tousled hair. "Well, suppose we figure this out mathematically. To make it easier to do mental arithmetic, let's say 100 mils flow through our field. That's not true, of course. Even if 100 mils flowed through the 450-ohm field, the current through the 3,000-ohm field would be less. Do you know why?"

After some thought Sally said: "I think so. As the other tubes get lower plate and screen voltages, it's obvious that they'll

(Continued on page 427)



# Electron Tubes

## From Brass-Base to Loctal

HOW far electron tubes have developed since the days of the good old 201A and its current-consuming parents, the 200 and 201 Servicemen of today, accustomed to octals and loctals, seldom stop to ponder on how these changes and improvements have been brought about. Truth is, that standard modern tubes are hardly recognizable as kin of their ancestors of the early '20's.

An interesting study of the evolutionary path of today's vacuum tube was recently made in *Sylvania News*. Each of the external changes in appearance was accompanied by—in many cases made possible by—changes in the hidden interior of the tube. Photo below shows four tubes identical as to function, (forms of the 6J7) in each of the four periods of tube history: glass, glass bantam, metal and loctal. Each tube is carefully cut in two to show how and why the development is possible.

The glass type at the right is to many old-timers a semi-modern tube. The earlier forms of glass envelope were straight-sided, the tube increasing in size to the top. Main feature of the large glass type is the high "press" or flattened glass piece through which all the leads enter the tube. The press occupies more than one-third the vertical height of the tube.

With the advent of the GT tube, the press was made considerably shorter. The old flaring type of envelope was entirely abandoned, the T (tubular) form being adopted. These changes were not for aesthetic reasons, of course. Other than the demand for greater compactness, the rising importance of high frequencies required a change in tubes. As can readily be seen from the photograph, the long space inside the old press tended to be crowded with wires. That they often lay close to each other is evidenced by the spaghetti insulation which was considered necessary. High tube capacities resulted from this arrangement. Another disadvantage was leakage, espe-

cially in humid climates, between elements whose spaghetti-insulated leads touched. Such leakage, especially in input circuits, was fatal to tube efficiency.

The GT tubes reduced the length of these external leads, at the same time cutting down capacity and the tendency of leads to come into contact with each other. The set-up was still not perfect, and awaited the coming of metal tubes for the next steps forward.

This next step was marked by total abandonment of the press. A glass header, through which all the leads passed, is sealed into a metal ring. This is welded to the metal envelope of the tube, resulting in a gas-tight seal. The header has two advantages over the press. Because it is flat, it takes up but a fraction of the room. The leads are sealed through it in a circle instead of a flat plane as in the older press. Thus each terminal can be brought out of the tube approximately above the position of its contact pin. Leads are correspondingly shortened and need for insulation within the tube base disappears entirely.

The loctal tube carries the process one logical step further, abandoning base pins altogether. The leads from the tube elements act as pins in the loctal, further simplifying tube construction, reducing lead length, and with it, stray capacity.

Shielding of leads is another point which gained importance only after the high frequencies were opened up. As will be seen in the photo, a metal shield is placed around the exhaust tube in both the GT and metal tubes. This shield is grounded to the No. 1 pin of the base, and serves to reduce capacities between the several leads. The brass base of the loctal tubes acts as shields, and special shielding is not necessary in this type.

As the photo below shows, changes in the

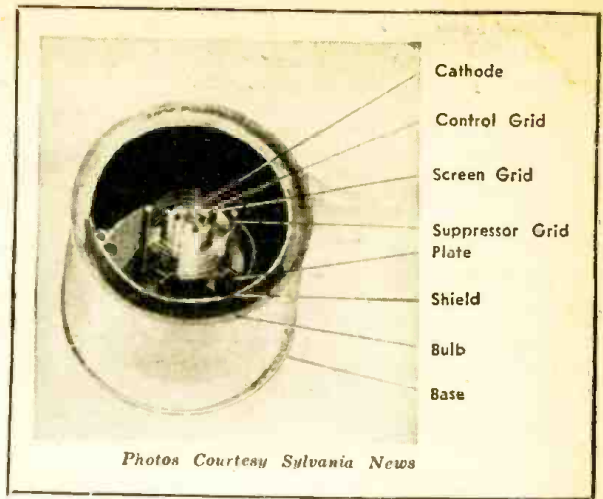

Photos Courtesy Sylvania News

tube have largely occurred at the base. The cut-away top of the tube looks much the same as would a similar one ten years ago. Only one difference is noted—the grid lead, which formerly came out the top, now leads through the base. Greater simplicity, shorter connections and again, lower tube capacities, are the advantages resulting from this change.

Post-war tubes—when micro-waves take the place now occupied by the "very high frequencies" (10 meters to 1 meter), will no doubt look even less like the present ones than these look like their ancestors. The strong possibility does exist that our present types may be sufficiently efficient in their own low-frequency field to exist alongside the newer forms.

## RECORDER TRAINS PILOTS

IMPROVED and unified flight instruction methods are expected to result from a detailed study of variations in teaching, now underway by the Civil Aeronautics Administration, through its recording of student-instructor conversation in flight with the new G-E "sound on wire" recorder.

The first instrument available after the recorder was reduced to practicability was installed in a training plane to delve into a problem that existed at a certain school. Some students were having difficulty in learning to spin and to recover from spins. When the wire was played back on the ground, the chief instructor found that one instructor reacted to the spin far more excitedly than was good for his students. He allowed his voice to rise in pitch and volume and literally scared the students into doing the maneuver incorrectly.

As in most cases where instruction methods are at fault, the instructor himself was among the most surprised. This ability of the recorder to reproduce the exact words and recreate the exact atmosphere of nerve tension during an instruction session, coupled with the requirement that instructors follow verbatim standard "patter" books in giving their lessons, makes possible the first scientific approach to the business of teaching persons to fly. The CAA tried for two years to get accurate information on what was happening in the training plane during instruction.

Difficulties centered around equipment that would not operate successfully in rough air, and around the problem of getting frequencies on which to operate radio transmitters in each of several planes.

This is the first application of the recorder in this country, and by any country, for instructional study purposes.

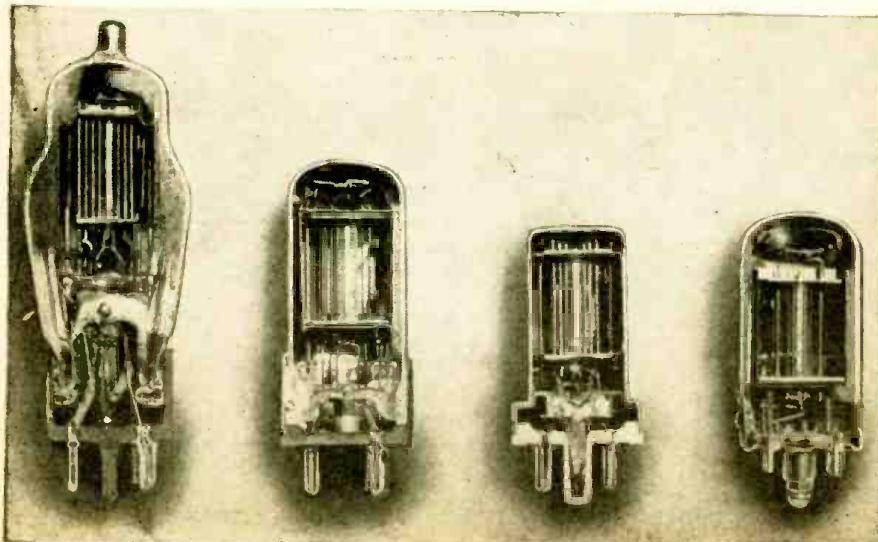

TYPE 6J7G

TYPE 6SJ7GT

TYPE 6SJ7

TYPE 7C7



# World-Wide Station List

Edited by ELMER R. FULLER

**R**ECEIVING conditions are now beginning to show much improvement, and it is hoped that much DX will be coming in in the near future. In our own listening post, much improvement has been noted in the past month, and more is ex-

pected with the coming of spring. "Radio Tokyo" is again being heard on the eastern seaboard, and report of other Asiatics have been finding their way to your editor's desk.

This month we have a revised list of the frequency modulated stations in the vicinity

of New York City. These were furnished to us by Winslow J. Williams, of Brooklyn, New York, who spends most of his listening time on these frequencies. Reports of frequencies and schedules of other FM stations would be greatly appreciated.

Mc.	Call	Location and Schedule	Mc.	Call	Location and Schedule	Mc.	Call	Location and Schedule
WNYE	42.1 mcs.	BROOKLYN, NEW YORK; daily, 1:45 to 2:15 pm.	WGYN	44.7 mcs.	NEW YORK CITY; 5 to 11 pm.	WABCFM	46.7 mcs.	NEW YORK CITY; daily, 4 to 10 pm.
W2XMN	42.8 mcs.	ALPINE, NEW JERSEY; daily 5 to 11 pm.	W2XWG	45.1 mcs.	NEW YORK CITY; Monday to Friday; 4 to 10 pm.	WBAM	47.1 mcs.	NEW YORK CITY; daily, except Sunday, 5 to 11 pm.
WNYCFM	43.9 mcs.	BROOKLYN, NEW YORK; daily, 4 to 10 pm.	WQXQ	45.9 mcs.	NEW YORK CITY; daily, 5 pm to midnight.	WABF	47.5 mcs.	NEW YORK CITY; daily, 3 to 9 pm.
			WHNF	46.3 mcs.	NEW YORK CITY; 2 to 9 pm.			

"Radio Brazzaville" and "Radio National Belge" are still coming in very fine business, and seem to be the only ones that can be depended upon to come in at almost any time and under all conditions. OPL, Leopoldville, Belgian Congo, comes in best on 9.785 mcs. from about 5 to 9 pm. FZI, Brazzaville, French Equatorial Africa, is heard best on 11.970 mcs., from about 4:45 to 8

pm. Both of these are heard at other times of the afternoon and evening.

We would like to have a few more observers to send us reports on first grade reception, and to supply us with information regarding frequency and schedules of short wave stations outside of the United States and Canada. If you are interested, please write to the editor, Elmer R. Fuller,

c/o Radio Craft, 25 West Broadway, New York City 7.

This month we publish the station list for 9 to 11 megacycles, inclusive, while next month we will give you the balance of the list. Any changes in the first third, published last month, are given at the beginning of this section. All schedules below are Eastern War time.

Mc.	Call	Location and Schedule	Mc.	Call	Location and Schedule	Mc.	Call	Location and Schedule
6.005	HP5K	COLON, PANAMA; evenings to 10 pm.	9.530	WGEO	SCHENECTADY, NEW YORK; East South American beam, 5:30 pm to midnight; European beam, 3:15 to 5:15 pm.	9.615	XERQ	MEXICO CITY, MEXICO; 10 am to midnight.
6.007	ZNS	NASSAU, BAHAMAS; 8 to 11 pm.	9.535	—	UNITED NATIONS RADIO — ALGIERS; heard Signing off Sunday at 4 pm; other times in evenings.	9.615	TIPG	SAN JOSE, COSTA RICA; "Voz de la Victor"; heard mornings and evenings.
6.120	—	TOKYO, JAPAN; North America beam, 9:30 to 10:30 pm.	9.535	SBU	MOTOLA, SWEDEN; Daily, 2:30 to 5:15 pm; 5:20 to 5:35 pm; 9 to 10 pm; Sundays, 2:30 to 5:15 pm; 5:20 to 5:40 pm.	9.620	—	LEOPOLDVILLE, BELGIAN CONGO; "National Radio Belge" heard afternoons.
6.180	XGEA	CHUNGKING, CHINA; heard mornings; girl announcer.	9.535	HER4	BERN, SWITZERLAND; North American beam, 7:30 to 9 pm; 9:30 to 11 pm.	9.620	—	ADDIS ABABA, ETHIOPIA; 11:30 am to 12:15 pm.
8.035	CNR	RABAT, MOROCCO; heard Sundays, 5 to 6 pm.	9.535	JZI	TOKYO, JAPAN; 1:20 to 4 am; 8 to 9:15 am; 10 am to 2:40 pm.	9.62	—	VICHY, FRANCE; North American beam, 8:15 pm.
8.83	COCQ	HAVANA, CUBA; daytimes.	9.54	VLG2	MELBOURNE, AUSTRALIA; Eastern North American beam, 1:10 to 1:40 am; 10 pm.	9.630	ZRO3	ROME, ITALY; off since September 8th, 1943.
8.930	KE52	SAN FRANCISCO, CALIF.; 6:15 am to 1 pm; Oriental beam.	9.54	AFHQ	ALLIED HEADQUARTERS, NORTH AFRICA; Relays "Voice of America" programs several times daily.	9.64	LRI	BUENOS AIRES, ARGENTINA; "Radio Belgrano"; evenings.
8.955	COKG	SANTIAGO, CUBA; 7:30 am to 11 pm.	9.54	MTCY	HSINGKING, MANCHUKUO; 9 to 11 am.	9.64	KZRH	MANILA, PHILIPPINES; 7 to 9:30 am.
8.960	AFHQ	ALLIED HEADQUARTERS, NORTH AFRICA; daily, early evenings.	9.54	XEFT	VERA CRUZ, MEXICO; 11 am to 2 am.	9.640	CXAB	MONTEVIDEO, URUGUAY; 5 pm to midnight; to 1 am on Sundays.
9.03	COBZ	HAVANA, CUBA; 9 am to 12:18 am.	9.545	XETT	MEXICO CITY, MEXICO; 10 am to 2 am.	9.64	CMZ	HAVANA, CUBA; heard afternoons.
9.125	HAT4	BUDAPEST, HUNGARY; 2 to 6 pm; 9 to 11 pm.	9.555	GWB	LONDON, ENGLAND; news at 2:30 am.	9.645	LLH	OSLO, NORWAY; 10 to 10:45 pm.
9.130	HI2G	CIUDAD TRUJILLO, DOMINICAN REPUBLIC; early evenings.	9.555	XEW	MEXICO CITY, MEXICO; 10 am to 5 pm; news (English) 4:50 pm.	9.645	JL72	TOKYO, JAPAN; noon to 2 pm.
9.185	COCQ	HAVANA, CUBA; afternoons.	9.562	OAX4T	LIMA, PERU; 7 to 10 am.	9.650	LDJW	BERLIN, GERMANY; 2 to 5:45 pm; 5:50 pm to 2 am.
9.250	COBQ	HAVANA, CUBA; 4 to 7 pm.	9.565	—	MOSCOW, U. S. S. R.; 6 to 7:30 am; 5:15 to 6:45 pm; 10 to 11:15 pm.	9.650	WCDA	NEW YORK CITY; European beam, 3:30 to 7 pm.
9.255	—	BUCHAREST, ROUMANIA; 4 to 5 pm; news (English) 4:50 pm.	9.565	JRAK	PARAO, PALAU GROUP (Japanese); 7 to 9:30 pm.	9.655	VLW4	PERTH, AUSTRALIA; heard mornings.
9.26	GSU	LONDON, ENGLAND; Near East, Africa, and Gibraltar beam, about noon.	9.57	KWIX	SAN FRANCISCO, CALIF.; South American beam, 8 pm to 12:45 am; Oriental beam, 1 to 2:45 am; 7:30 am to 4:45 pm.	9.660	VUD6	DELHI, INDIA; news irregularly at 8 am.
9.29	HI2G	CIUDAD TRUJILLO, DOMINICAN REPUBLIC; Sunday afternoons.	9.570	KWID	SAN FRANCISCO, CALIF.; Australian beam, 3 to 6:15 am.	9.660	VLQ3	BRISBANE, AUSTRALIA; Sunday to Friday, 3:30 to 7 pm; 8:45 pm to 3:35 am; Saturdays, 3:45 pm to 3:35 am.
9.295	COCX	HAVANA, CUBA; daytimes.	9.570	WRUS	BOSTON, MASS.; North Africa, 4:45 to 7:15 pm.	9.660	LRX	BUENOS AIRES, ARGENTINA; "Radio El Mundo" relaying LRI; 5 pm to midnight.
9.35	COBC	HAVANA, CUBA; 9 am to 1:15 am.	9.580	GSC	LONDON, ENGLAND; North America beam, 5:15 to 10:15 pm.	9.660	HVJ	VATICAN CITY; 11 am to 1:45 pm; 7:45 to 8:10 pm.
9.437	COCH	HAVANA, CUBA; 7 am to 1 am.	9.58	VLG	MELBOURNE, AUSTRALIA; 11 to 11:45 am.	9.665	XGOI	SHANGHAI, CHINA; operated by Japanese; 8 to 9 am.
9.455	GRU	LONDON, ENGLAND; 1:30 to 5 am; 6 to 10:30 am; 1:30 to 2:15 pm; 3 to 6 pm; 7 to 10:45 pm; 11:45 pm to 12:45 am.	9.590	WCDA	NEW YORK CITY; European beam, 6 to 7:30 am.	9.665	—	PERTH, AUSTRALIA; 8:15 to 9:55 pm; to Southeast Asia.
9.465	TAP	ANKARA, TURKEY; 2 to 3:45 pm; 3:50 to 4 pm.	9.595	—	ATHLONE, IRELAND; 5:10 to 5:30 pm.	9.665	—	ITALIAN UNDERCOVER STATION; 7 to 7:20 pm.
9.470	CR6RA	LOUANDA, ANGOLA; 7:30 to 8:45 am; 3:30 to 5 pm.	9.600	GRY	LONDON, ENGLAND; 1 to 2:45 am; 3:30 to 10:30 am; 2:15 to 5 pm; 5:15 to 6:45 pm.	9.670	WRCA	NEW YORK CITY; Brazilian beam, 8 to 11:30 pm.
9.480	CP3B	LA PAZ, BOLIVIA; 7 to 11 pm.	9.600	CE960	SANTIAGO, CHILE; 8 pm to midnight.	9.670	WN8I	NEW YORK CITY; European beam, 12:15 to 2 am; 6 to 7:30 am; 3:45 to 5:15 pm.
9.485	—	"SLOVAK FREEDOM STATION"; Saturdays 4:30 to 4:42 pm.	9.607	HP5J	PANAMA CITY, PANAMA; evenings.	9.675	DJX	BERLIN, GERMANY; 11:20 am to 5:33 pm.
9.490	KRCA	SAN FRANCISCO, CALIF.; 1 am to 1 pm; Oriental beam.	9.608	ZRL	CAPE TOWN, SOUTH AFRICA; 11 to 11:45 am.	9.675	JVW2	TOKYO, JAPAN; 5 to 8 am; 10 am to 12:15 pm.
9.490	WCBX	NEW YORK CITY; Latin American beam, 5 to 11:30 pm.	9.610	DX8	BERLIN, GERMANY; 2 to 5:45 pm; 5:50 to 7 pm; 10 pm to midnight.	9.680	XEQQ	MEXICO CITY, MEXICO; 10 am to 2:45 am.
9.495	OIX2	HELSINKI, FINLAND; 4 to 5 pm.	9.610	ZYCB	RIO DE JANEIRO, BRAZIL; 6 to 11 pm.	9.68	VLW6	PERTH, AUSTRALIA; 6 to 10:50 am; 9 pm to midnight.
9.500	XEWW	MEXICO CITY, MEXICO; 9 am to 3 am.				9.685	TGWA	GUATEMALA CITY, GUATEMALA; 9:55 pm to 12:45 am.
9.505	JLG2	TOKYO, JAPAN; North American beam, 11 am to 2:40 pm; 11 pm to 4 am.						
9.510	G5B	LONDON, ENGLAND; 2 to 3 pm.						
9.52	DXL13	PARIS, FRANCE; relays Berlin to North America, 5:30 pm to midnight.						
9.530	WGEA	SCHENECTADY, NEW YORK; 3:30 to 6 am, European beam.						

(Continued on page 439).

# USEFUL SPEAKER TESTER

By using the unit described herewith, it is possible to substitute a speaker or transformer, or both.

If the radio has a push-pull output circuit jacks J1 and J3 are connected to the plates and J2 to B+.

Where there is only a single output tube J1 jack is connected to the plate and J2 to the B+.

After the proper plate connections have been made it is necessary to connect the voice coil to the proper secondary terminals of the output transformer.

The correct terminals may be determined by referring to the chart which usually ac-

By ARCHIE V. CARPENTER

companies universal transformers in their cartons.

If terminals 3 and 5 are indicated, all that is necessary to be done is to throw switches 3 and 5 to "test position," and the speaker is thereby connected to the radio with proper impedance ratio.

If the chart is not handy the proper switches may be found by trial, but only

two switches should be in "test position" at any one time, but Switch No. 7 must be in position A.

When desired, the loudspeaker on the radio set may be tested simply by disconnecting the voice-coil of the speaker from the associated output transformer, and using leads with clips to connect the voice coil of the speaker to J4 and J6, with switch 7 in position B.

The impedance may be matched by throwing the proper pair of matching switches to test position.

If the output transformer in the radio is O.K., and the trouble is with the speaker, the test speaker can be connected to the output transformer of the radio by connecting the clips to the secondary of the output transformer through J4 and J5. Switch 7 should be in position B. The output transformer of the tester is not used, and there are no means of matching impedance—it simply provides a check on the output transformer of the radio set.

Now a word in explanation of the use of the six matching switches. Each switch is connected to the corresponding terminal on the universal output transformer, and when in test position connects one side of the voice coil to the corresponding terminal of the output transformer. By using a certain pair of switches, the voice coil may be connected to a corresponding pair of secondary terminals on the output transformer.

The above may sound somewhat complicated, and the unit in fact looks so, but in practice it will be found that a few settings are standard for practically all speakers tested. If a few labels are pasted under the switches, all operations and settings become clear to even a new user of the instrument.

This unit is quite useful, as it facilitates the removal of a receiver to the shop without bothering with the speaker; also where an output transformer is to be replaced, if the same type of transformer is used for replacement as the one in the tester, it will help to determine the correct pair of secondary terminals to use.

## Parts List

- P-5—Tip plugs
- C5—Pee-wee battery clips with insulators
- V.C.—Voice coil of P.M. speaker
- 1—S.P.S.T. toggle-switch
- 2,3,4,5,6—D.P.D.T. toggle-switches
- 7—S.P.D.T. toggle switch

# ADD A TONE CONTROL

By FRED U. DILLION

MANY of the little 4-tube midsets the serviceman sees so often nowadays can be greatly improved by the addition of a tone control. These sets were very cheaply made in most cases, and have three controls—tuning, A.C. switch and volume. The low price for which they were built to sell precluded their having a tone control. Such sets were generally used as "second receivers" until war conditions forced many of them into a position where a family may depend on one of them for all its radio entertainment.

The type of control shown here is an improvement over many which are recommended for installation. The usual control acts as a by-pass to radio frequency as well as audio when the control is turned to bass. As it is moved to treble, this by-passing is lost. On the control shown in the diagram, a small condenser takes over as the control is turned up toward treble, retaining the by-passing effect.

By carefully increasing the size of the condenser at the treble end, high-pitched hissing and tube noises may be taken out without greatly affecting the high notes. This is valuable in noisy areas. The double-ended feature may be retained if the control

is mounted in the plate circuit of the power output tube, the treble-end resistor being used to take out the high-pitched noises just mentioned.

This is by no means a "compensated tone control," but if you have a tapped control, the usual compensating condenser, or condenser and resistor, can be inserted without having any effect on the other features of the circuit.

Installation is simple. The A.C. line switch is removed, and a tone control with switch is mounted in its place. The two wires from the old switch go to the new one and the tone control is wired as in the diagram. If connected in the detector plate circuit, the lead running to the center arm may have to be shielded and the shield grounded.

When purchasing a tone control be sure to get one designed with a taper especially designed for tone-control operations, so that the action will be spread evenly over the whole length of rotation, instead of being bunched at one end of the range.

This tone control circuit can be adapted to any set, or to receivers which already have tone controls, but are not giving satisfactory service. Just rewire as per diagram.

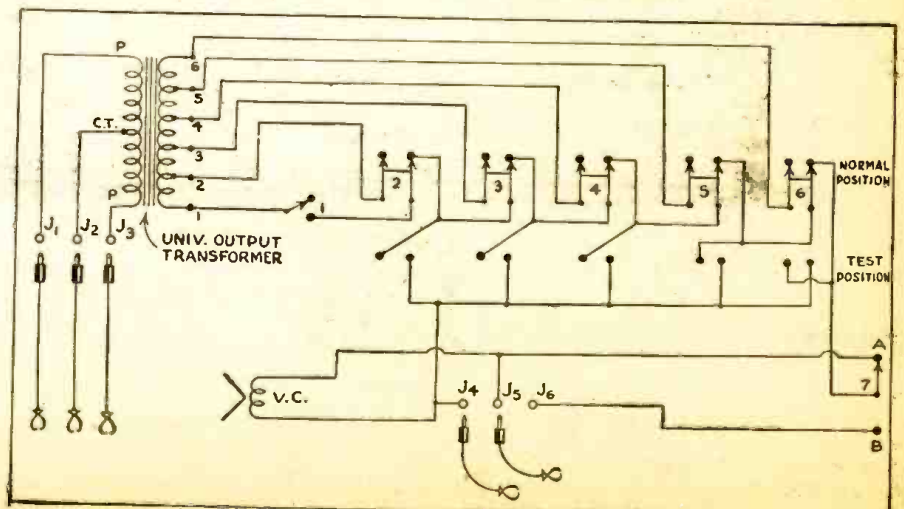
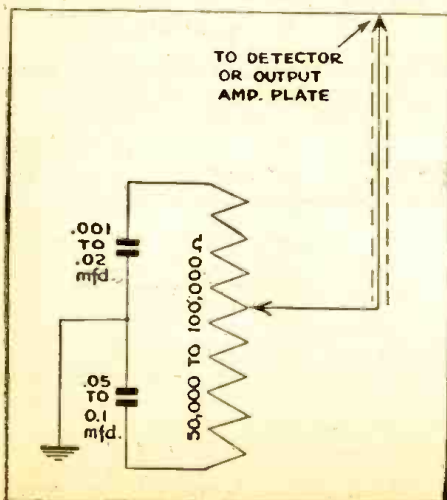

# THE MOST RADIO-ELECTRONIC TRAINING

★ in the shortest time  
★ at the lowest cost

## FOR BEGINNERS . . . no previous training necessary

You can pay a big price for basic Radio-Electronic Training—but the amazing fact remains that Ghirardi's famous 972-page RADIO PHYSICS COURSE book will give you just the training you need, all you need—and easier, better, and faster—at a total cost of only \$5 complete!

### LEARN EASIER—BETTER—FASTER

With other types of training selling for as much as \$150 that's a big statement to make—BUT HERE ARE THE FACTS: Ghirardi's big RADIO PHYSICS COURSE book has given more people their start in Radio than any other book or course. It is more universally employed in U. S. Army Signal Corps and Navy Schools than any other book of its kind.

It is more widely used for home study—and by civilian schools and colleges. Most important of all, it is more widely endorsed by thousands of radio men themselves as the finest, most complete, easiest-to-understand Radio-Electronic course on the market. What better proof would you want than this?

No previous knowledge of Radio-Electronics is necessary. Ghirardi's Radio Physics Course carries you rapidly along

from the very basic fundamentals of Electricity to the latest, most modern Radio-Electronic developments. Nothing is omitted—nothing condensed. Every step is made crystal clear and understandable by thorough, simplified explanations, and by more than 500 specially prepared illustrations. Each section is followed by self-testing review questions so that you can check your progress every step of the way. There are no monthly lessons to wait for. You go ahead as fast as you want to. All you need is a little spare reading time plus a desire to get started RIGHT for a worthwhile future in broadcasting, aviation radio, servicing, electronic manufacturing television—or any other of Radio-Electronics' fast growing branches.

### 36 COURSES IN ONE!

Actually, RADIO PHYSICS COURSE gives you the scope of 36 complete courses in one big book. If it were broken into sections and sold as a course, you'd regard it as a bargain at \$50 or more. It's yours, however, for only \$5 complete (\$5.50 foreign)—and you don't even take the slightest chance on that! Our 5-Day Money-Back Guarantee is your absolute protection. Send the coupon today!



SEE IT • STUDY IT • BEFORE YOU BUY IT

Here's how sure we are that you will like it:

Judge Ghirardi's RADIO PHYSICS COURSE for yourself. Compare it with any other Radio book or course at any price. Use it for 5 full days. Then, if you are not convinced that it will teach you basic Radio-Electronics EASIER, FASTER, and at LESS COST, return it and we will send your MONEY BACK!

## HERE'S HOW TO "TEST" A RADIO IN TWO MINUTES . . . or less!

Then fix it in half the time you'd expect to take

If you repair Radios for a living—or, even if you only tinker with sets occasionally, this big, new, completely revised edition of Ghirardi's famous RADIO TROUBLESHOOTER'S HANDBOOK is a book you cannot afford to miss! This big, 744-page, manual-size book is a complete guide to trouble diagnosing, locating, and fast repairing for practically EVERY type of Radio Receiver now in use. It eliminates extensive testing; helps you do two jobs in the time normally required for one; repair cheap sets at a profit; substitute available tubes and parts properly; train new helpers, etc.

New, fully revised, the RADIO TROUBLESHOOTER'S HANDBOOK now contains 404-page Case History compilations covering over 4,800 models of receivers and record changers—I.F. alignment peaks for over 20,000 superhets; big section on I.F. trans, troubles, and hundreds of tables, graphs, charts, and data sections, including a big new tube chart ESPECIALLY DESIGNED FOR WARTIME SERVICE NEEDS. It is yours complete for only \$5 (\$5.50 foreign) on an absolute 5-DAY MONEY-BACK GUARANTEE BASIS.

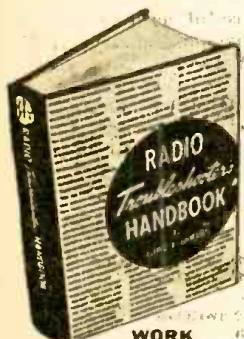

WORK TWICE AS FAST!

"It has helped me fix twice as many radios in a day as I could fix before owning this book," writes Vernon Taylor of Elgin, Texas.

## THIS GHIRARDI WINNER WILL TEACH YOU RADIO SERVICING!

How would you like to have Radio's most widely-acclaimed servicing expert at your side to teach you everything you need to know to help make you an accomplished radio service man? Actually, ownership of Ghirardi's MODERN RADIO SERVICING means just about that! It is the only single, inexpensive book that gives a thorough and easily understandable explanation of test instruments; receiver trouble-shooting procedure; circuit analysis; parts testing and repair; maintenance, etc. 1300 pages with 706 illustrations, 720 self-testing review questions; 766 different topics! Only \$5 complete (\$5.50 foreign).

See MONEY-SAVING COMBINATION OFFER in Coupon



RADIO & TECHNICAL DIVISION OF MURRAY HILL BOOKS, INC., Dept. RC-44, 232 Madison Ave., New York 16, N. Y.

Enclosed find \$..... for books checked (send postpaid); or  send C.O.D. (in U.S.A. only) for this amount plus postage. If I am not fully satisfied, I may return the books within 5 days and receive my money back.

RADIO PHYSICS COURSE \$5.00 (\$5.50 foreign)

MODERN RADIO SERVICING \$5 (\$5.50 foreign)

3rd Revised Ed. RADIO TROUBLESHOOTER'S HANDBOOK \$5 (\$5.50 foreign)

Special MONEY-SAVING COMBINATION: MODERN RADIO SERVICING with the TROUBLESHOOTER'S HANDBOOK \$9.50 for the two (\$10.50 foreign)

Name .....  
Address .....  
City and Dist. No. .... State .....

REPAIR ANY KIND OF RADIO EQUIPMENT  
PREPARE YOURSELF FOR A BETTER JOB AT HIGHER PAY IN THE RADIO-ELECTRONIC FIELD

# New Radio-Electronic Devices

## SQUARE-WAVE GENERATOR

Reiner Electronics Co.  
New York, N. Y.

**A** NEW low-priced Square Wave Generator Model 530, designed for production testing. It incorporates a feature not found in other square wave generators, the facility of synchronization with any external frequency source.

Model 530 Square Wave Generator has a hand-calibrated frequency scale reading from below 10 cycles to more than 100 kilocycles. The Decade Multiplier has four steps. The actual frequency of the output is the dial reading multiplied by the setting of the frequency multiplier. The accuracy of the frequency calibration is 5% over extended periods.

In cases where great accuracy of frequency is desired, the instrument can be made to synchronize with any standard frequency generator, provided that a synchronizing voltage of at least 0.1 volt is available. The synchronization can also be made with any other external frequency source.

The output impedances available are 100-200-500-600-1,000-2,000 ohms. Output voltage may be varied either in fixed steps or may be continuously varied by means of the variable voltage potentiometer. When the latter is used, the output impedance is from 0-2,000 ohms.

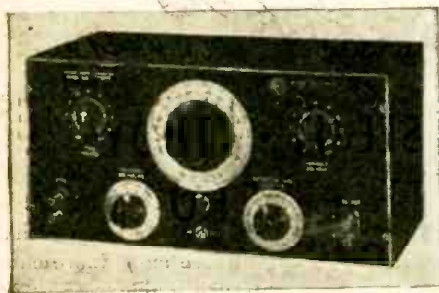

If the output voltage is varied in steps, the output impedance is indicated by the output voltage selector setting. The maximum voltage output is approximately 200 volts.

The power supply of Reiner Electronics Model 530 Square Wave Generator is designed to operate on 110-120 volts, 60 cycle A.C. It is also available for other voltages or line frequency at slightly additional cost. The power consumption is 30 watts, fuse protection, 1 ampere.

Model 530 Square Wave Generator is 8" in height, 9" in depth, 15" in width and weighs 18 pounds.—Radio-Craft

## ELECTRONIC HEATING CAPACITORS

Barker & Williamson  
Upper Darby, Penna.

**K**NOwn as B & W Type CX Variable Condensers, these units are of sturdy, unconventional design offering many advantages for heavy-duty applications. Features include perfect electrical design symmetry and built-in neutralization coupled with extreme mechanical durability. Their construction also lends itself admirably



to the built-in mounting of standard inductors in such a way that lead lengths and resulting lead inductance are reduced to an absolute minimum.

B & W Type CX Variable Condensers are available in almost any required capacity for electronic heating use up to 5 kw., 12,500 volts.—Radio-Craft

## SYNTHETIC DIELECTRIC

General Electric Co.  
Schenectady, N. Y.

**L**ECTROFILM, a new synthetic dielectric material for capacitors, can be best applied to the manufacture of most radio-frequency-blocking and by-pass, fixed capacitors used in communications and other electronic equipment. The new product has a greater combination of desirable properties than was previously available in any one dielectric material. It is available in both rolls and sheets and can be used in present capacitor production lines with very little change in equipment or methods.

In addition, lectrofilm's strength and flexibility make it well-suited to automatic methods of manufacture. The careful control used in its production, together with its chemical stability, assure uniform properties and freedom from defects. Furthermore, it requires little grading or sorting before being placed into a capacitor production line. Compared with other dielectrics, lectrofilm requires less inspection and, properly applied, its use will cut down the number of finished capacitors that are rejected in test, thereby reducing the amount of labor and increasing production with present facilities.—Radio-Craft

## DUST-PROOF RELAYS

Struthers-Dunn Inc.,  
Philadelphia, Penna.

**D**ESIGNED for rough and tumble airplane use where the utmost precaution must be taken against unintentional operation of contacts, the Struthers-Dunn Type 17AXX relay meets and exceeds all specified requirements for this type of unit.

Actual tests, show that it will withstand acceleration tests of better than 90 gravitational units—or from eight to ten times the G-rating of ordinary relays.

Despite its exceptionally rugged construction, the relay is small in size, and light in weight. Units of this type are regularly supplied with series coils for any direct current, or with shunt coils for use on 12- or 24-volts D.C.—Radio-Craft

## NEW PLASTIC GROMMETS

Creative Plastics Corp.  
Brooklyn, N. Y.

**O**F special interest to production engineers seeking to cut down assembly time operations, this new line of 100% phenolic plastic insulating grommets offers many important advantages. These new grommets, available in four standardized sizes, have been developed especially for use by Radio, Motor and Electronics manufacturers. Holes are concentric, with all corners chamfered, avoiding wire chafing. All threads are clean and lubricated. To promote easy gripping and conservation of assembly time, all parts are matte finished.—Radio-Craft

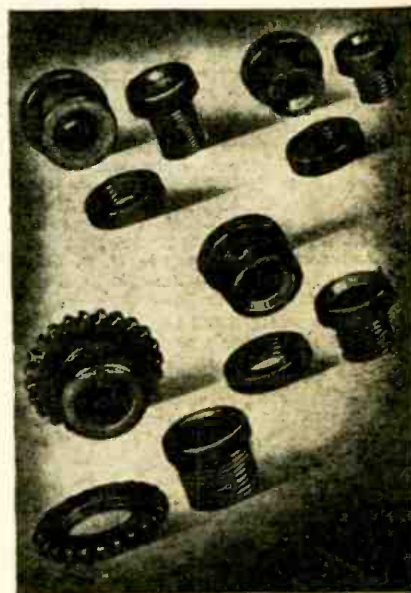

## POWER SUPPLY UNITS

Communications Measurements Laboratory  
New York, N. Y.

**I**DENTICAL in performance, Communication Measurements Laboratory's two new 1100 series power supplies differ only in construction. Model 1100 is a table model for use in the laboratory, while the Model 1110 is designed for rack mounting. Both units use the familiar series regulator circuit. To insure low noise level and better regulation, a high gain two stage control circuit is used, instead of the conventional single stage circuit. The high voltage output can be shifted through a range of 225 to 325 volts by means of the potentiometer control on the front panel. The maximum current drain is 200 milliamperes from 225 to 300 volts and 180 milliamperes from 300 to 325 volts. Under these conditions the sum of all AC components present in the output is less than 5 millivolts. The change in voltage output from no load to full load is less than one volt. The primary of the power transformer is tapped for use at 105 volts, 115 volts and 125 volts on a 50-60 cycle source. An unregulated heater supply winding of 6.3 volts at 5 amperes is furnished.—Radio-Craft

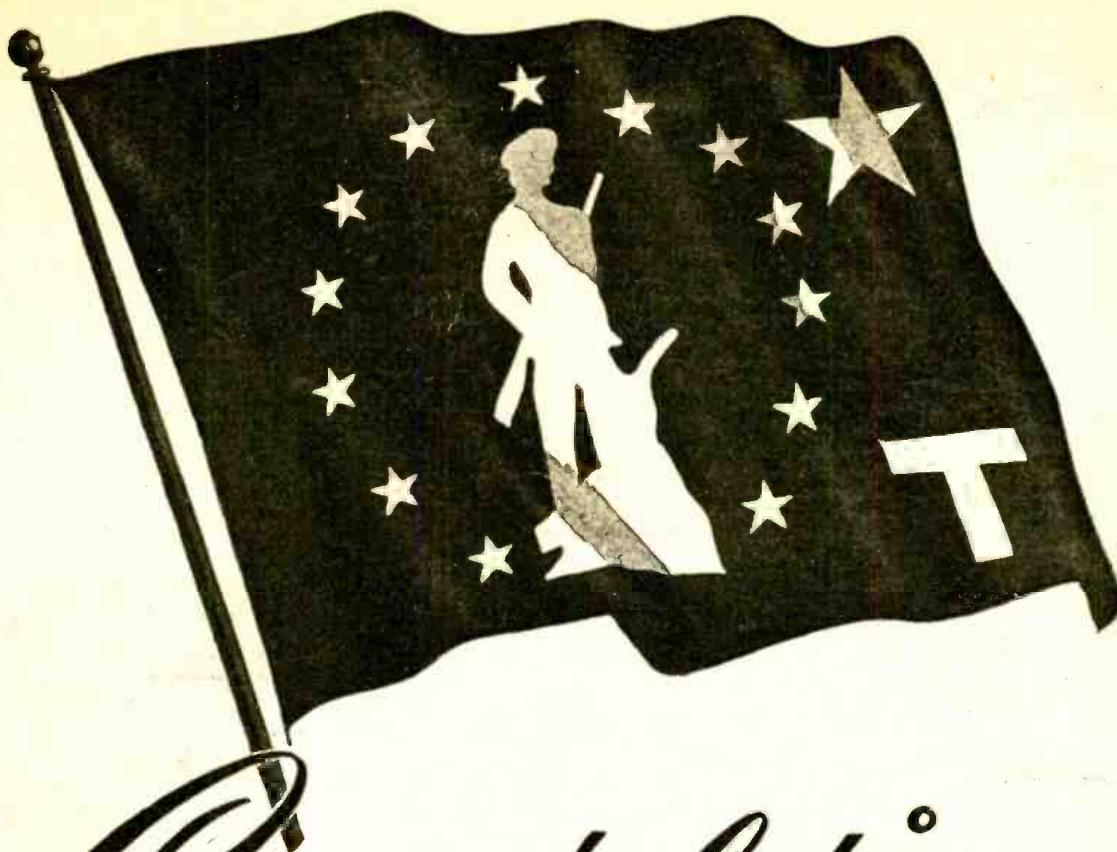

# Congratulations

## ON A FINE JOB, WELL DONE!



**T**HE Treasury "Star" Flag—the bond-buying counterpart of the Army-Navy "E"—marks plants with at least 90% of personnel participating in the Payroll Savings Plan to at least 10% of gross payroll, and also having reached, or topped, a War Loan Drive quota!

The successful close of the 4th War Loan Drive finds many more "Star" Flags than ever before flying over the industrial plants of America. To all these, go the heartiest thanks of the nation, and the deep appreciation of the Treasury Department for a great job! And to those who may not quite have qualified for the "Star," go equally sincere thanks—and the confidence that soon they, too, will join the ranks of the "Star" fliers.

One thought that many concerns have

found helpful in stepping up the intake from their Payroll Savings Plans is this. In many cases the Treasury Representative in a plant has been able to point out the fact that during *Loan Drive periods* the employees have found it possible to spare much more than they had counted on when setting up their original subscription, and that—*when properly approached*—a very substantial fraction of such employees will decide they can well afford a distinct increase in their current Payroll Savings Plan.

Talk this over with your Treasury Representative—it offers important possibilities when correctly handled. And again accept the Treasury Department's congratulations for your fine work in helping to put over the 4th War Loan.

*The Treasury Department acknowledges with appreciation the publication of this message by*

**LET'S ALL KEEP  
BACKING THE ATTACK  
WITH WAR BONDS**

**RADIO-CRAFT**

*This is an official U. S. Treasury advertisement—prepared under auspices of Treasury Department and War Advertising Council.*

# THE QUESTION BOX

## RECORD PLAYER

**?** Will you please publish an amplifier using 232L7's and a 6J7. This is to be used for playing phonograph records. My pickup is of the magnetic type.—S.S., N.Y.C.

**A.** Since it is extremely doubtful if—even with transformer coupling—one 6J7 could drive your two 32L7's and deliver any volume or quality, we are taking the liberty of adding another tube, a 6C8. This is used as a phase inverter, between the 6J7 and the two output tubes. (See Fig. 1.)

A transformer will be required to couple your magnetic pickup to the grid circuit of the 6J7. If you cannot get one adapted to your pickup, try an audio transformer. A high-ratio type, 5 to 1 or more, works best. For some of the lowest-impedance pickups, such as the old RCA, a microphone transformer works well.

## AN ALL-WAVE RECEIVER

**?** Please send me a schematic diagram of an all-wave receiver using a 12A7 and a 6F7, a line cord resistor, and one stage of R.F. ahead of the detector.

I would like to have all the necessary information on winding the coils for this receiver.—E.B.S., Norfolk, Va.

**A.** You will find the schematic shown in Fig. 2 satisfactory. Coils on the receiver may be wound as follows, two identical coils being used for each band.

Ant. or Plate Turns	Grid Turns	Wire Size	Spaced
16	80	28	1 7/8
12	40	26	1 5/8
8	20	24	1 1/2
6	10	16	1 1/4

All coils are to be wound on the standard 1 1/2 inch coil. Antenna or plate turns are all No. 30 closewound. A broadcast coil with grid coil of 130 turns No. 28 and primary of 30 turns of No. 34 or so, may also be used. Single-gang tuning condensers should be used to eliminate tracking difficulties. Use a 300-ohm line cord in series with the filaments, putting the 12A7 next the positive side of the line.

All queries should be accompanied by a fee of 50c to cover research involved. If a schematic or diagram is wanted, please send 75c, to cover circuits up to five tubes; over five tubes, \$1.00.

Send the fullest possible details. Give names and MODEL NUMBERS. Include schematics whenever you have such. Serial numbers of radios are useless as a means of identification.

All letters must be signed and carry FULL ADDRESS. Queries will be answered by mail, and those of general interest reprinted here. Do not use postcards—postmarks often make them illegible.

No picture diagrams can be supplied. Back issues 1943, 25c each; 1942, 30c each; 1941, 35c each. 1940 and earlier, if in stock, 50c per copy.

## A GOOD AUDIO AMPLIFIER

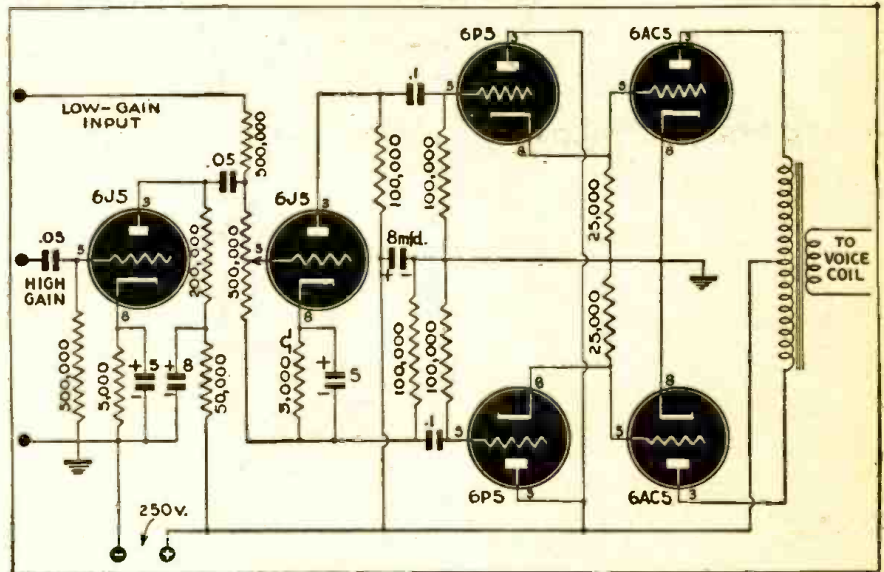

**?** Will you please design me a good audio amplifier for phonograph and FM or AM tuner? I have on hand three 6P5's, two 6J5's and two 6AC5's, all of the glass type.

If possible, will you please show a simple way to use a 6L6 as a volume expander in this circuit?—R.W.J., Los Angeles, Calif.

**A.** The schematic shown should give you good results. The first tube may prove unnecessary, unless you intend to use the amplifier with a low-gain microphone. Cer-

tainly it will not be needed after a pickup or a radio tuner.

The 6AC5 is an especially interesting audio amplifier, in that the grid is maintained at a positive potential, contrary to general practice. The correct voltage is +13.

Any type of power supply capable of delivering 100 milliamperes or more at 250 volts may be used with this amplifier.

I know of no way to use one 6L6 as a volume expander. Most circuits of this type use at least three tubes.

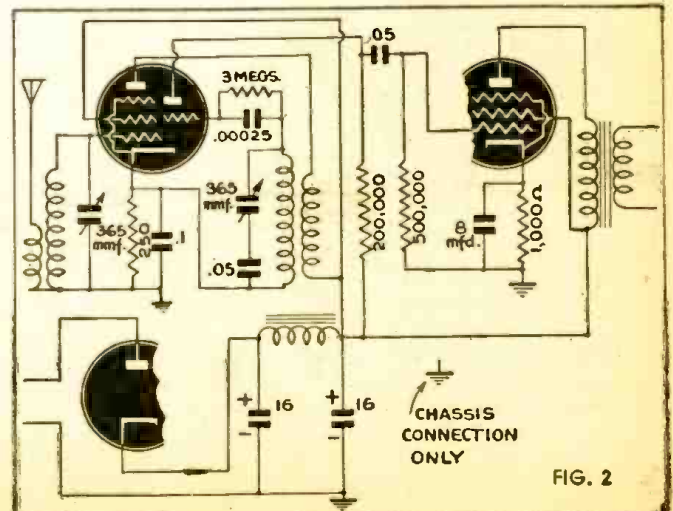
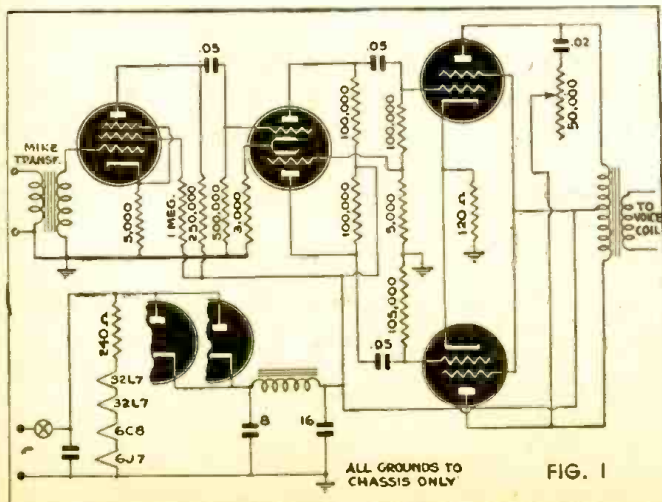

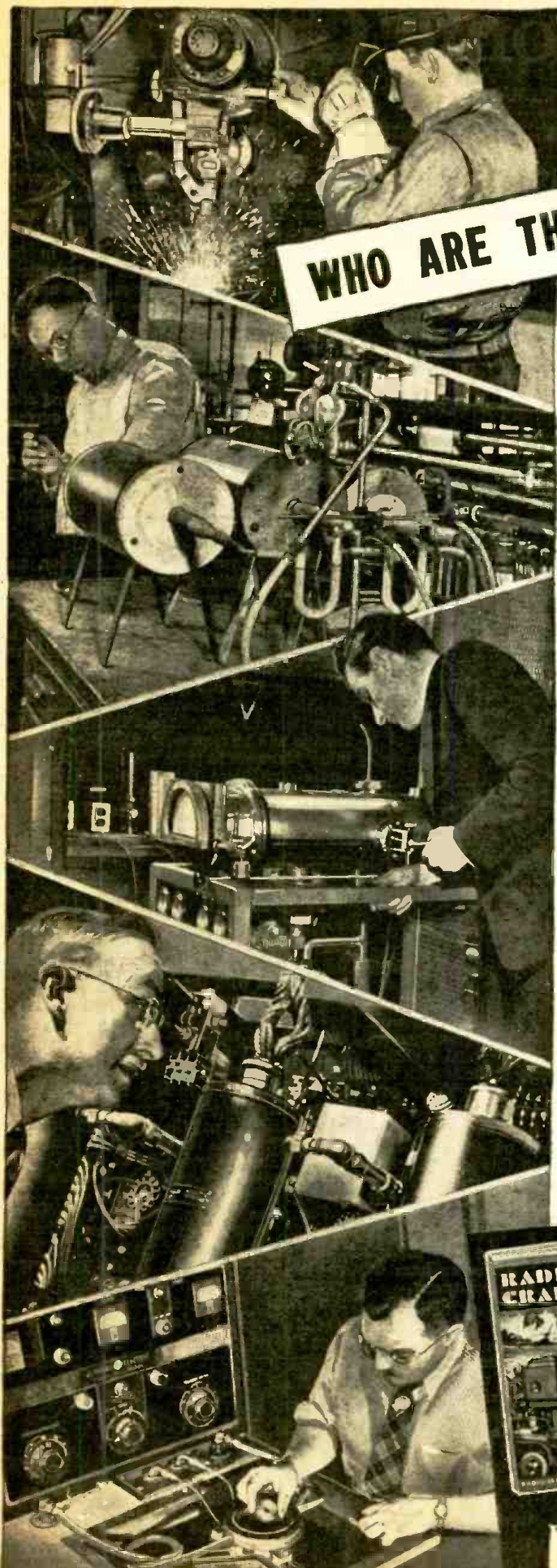

## A MESSAGE TO MANUFACTURERS

**WHO ARE THE 47,000 MEN . . .**

# . . . who read RADIO-CRAFT this month

YESTERDAY they were the students, operators, "hams", engineers and technicians . . . TODAY they are skilled engineers and officers of essential industry and the military who are doing their vital part in communications for the war effort of the United Nations . . . TOMORROW they'll be the leaders and top ranking engineers who will direct the destinies of radio and electronics.

**47,000 MEN** like these who know "the future belongs to those who prepare for it" read RADIO-CRAFT this month . . . and read it because they want to broaden their perspective on today's wartime problems and developments that will inevitably shape their post-war futures. They are the Radio-Electronic Intelligentsia — who know all there is to know about the new, promising field of Electronics.

**47,000 MEN** who now and in the post-war future will influence the use and purchase of your products!

## RADIO-CRAFT

25 West Broadway, New York 7, N. Y.



— at less than —  
**1¢ PER READER**  
you can reach  
**47,000**  
Radio-Electronics men  
with

**RADIO  
CRAFT**  
AND POPULAR ELECTRONICS

*Photographs used by courtesy of General Electric Co. and Radio Corporation of America.*

# Radio-Electronic Circuits

## EXPERIMENTERS!

*Radio-Craft* is initiating a plan to overcome the bottlenecks created by the unavailability of many standard types of apparatus. The ingenuity of the American experimenter, technician and mechanic is hereby challenged to replace, rebuild or substitute unrepairable or unobtainable equipment.

Every month one project will be announced for the readers of this page to exercise their brains on. *Radio-Craft* will pay a

FIRST PRIZE OF \$5.00

for the best answer and one-year subscriptions for all others published.

**PROJECT FOR THIS MONTH:** Bottleneck No. 1—High-Resistance relays. As every technician knows these are impossible to obtain. How do our readers meet the problem thus posed? Send your solutions—construction, substitution, etc.

Suggestions from readers as to other bottlenecks are also welcome. What is your present pressing problem? If you want help with it, tell us so that we can all get to work on it.

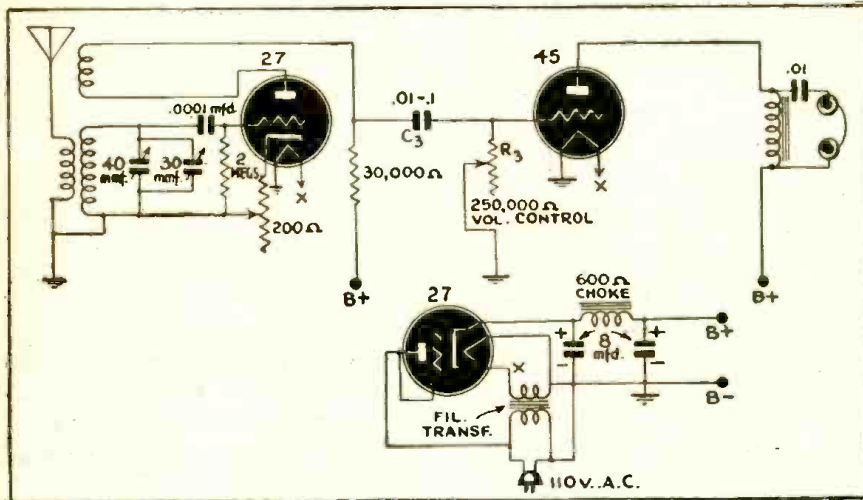

## THE SHORT-WAVE "SUPERB" RECEIVER

This set brought in those far-off, hard-to-get stations for me. Standard 6-prong short-wave coils were used, although, if the experimenter prefers, an antenna condenser and 4-prong coils would work well.

By using the variable resistor in the cathode circuit it is easy to control oscillation. A separate volume control is used in the audio circuit so the regeneration control can be set at the best point for maximum sensitivity and selectivity, instead of being used as a combined volume and regeneration control.

It was necessary to put a choke and condenser in the phone circuit, as the current is a little too heavy for the phones.

The 27 was used as rectifier because it was on hand. A 1-V. would have been better, but needed another filament winding.

JEROME N. SEIBERT,  
St. Paul, Minn.

(Why not use the 45 as a rectifier, and the 27, with cathode resistor, as audio amplifier? A 27 is even better suited to feed into the headphones than is the 45, and will give more gain. On the other hand, the 45 will amply supply the power requirements of the receiver, where a 27 as rectifier cannot supply enough current for the 45 amplifier. The filament transformer isolates the 45 filament from the line, and no trouble will be experienced in operating the other filaments at plate voltage. Used as an audio amplifier, the 27 should have a cathode resistor of about 2,500 ohms and a cathode by-pass condenser of about 10 mfd.—(Editor.)

## VIBRATOR POWER PACK

The battery shortage forced me to construct a power supply for my 2-volt radio.

I built it on the base of an old Majestic power supply, from which I took off everything but one filter choke and the 4-prong socket (used to plug in the vibrator). All other parts, with the exception of the "A" filter choke, which I made myself, were new. Vibrator was a Philco No. 83-0025. Transformer was also a Philco of not too heavy a design.

The new vibrator transformer, filter condensers and chokes were all mounted on top

of the chassis, which is about an inch high.

The choke in the "A" circuit was made by winding 200 turns of No. 30 D.S.C. wire on the core of an old audio transformer, and serves as both a resistor and a choke.

I expect to wind a bigger choke with No. 24 wire on a much larger core. When just the resistor was used, hum was very bad.

There is still some hum and hash when the "A" supply is taken off the same battery as the vibrator, but this is not noticeable on local stations, or on distant stations with the volume full on. When used with a separate battery for the "A" supply, there is no hum or hash whatever.

I have built over many of the older type of battery sets to work on 1.4 volts, and also converted electric sets to work on battery and vice versa, but this is my first experience with a vibrator unit. I would be interested in seeing how others have solved this.

REGINALD H. COX,  
Hoyt St., N. B.

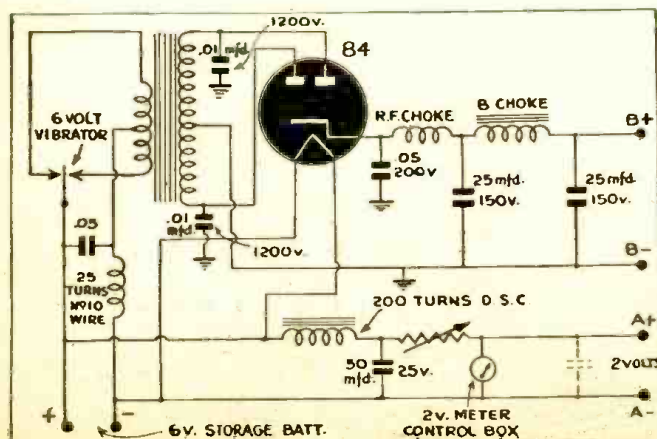

## AMPLIFIER FOR CRYSTAL

The highest possible fidelity is obtainable from a crystal receiver, as will be admitted by anyone who tries this circuit in comparison with the best high-fidelity multi-tube receivers.

To receive local stations on a small speaker, an amplifier stage consisting of one 70L7-GT has been added. Phones can be used for weaker stations.

The circuit shown is a little more elaborate than that of the ordinary crystal receiver. It will pay the constructor in greater selectivity. L<sub>1</sub> consists of 65 turns, and L<sub>2</sub> of 75 turns, or No. 22 D.C.C. wire, wound on a cardboard tube 3 inches in diameter.

For more volume, any large, high-fidelity audio amplifier may be used. The amplifier must be of excellent quality if the advantage of using a crystal receiver is not to be lost.

RALPH DAY,  
St. John, New Brunswick

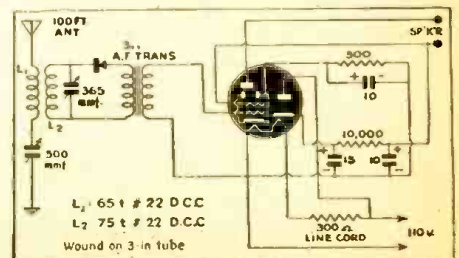



# The fight on the doorstep

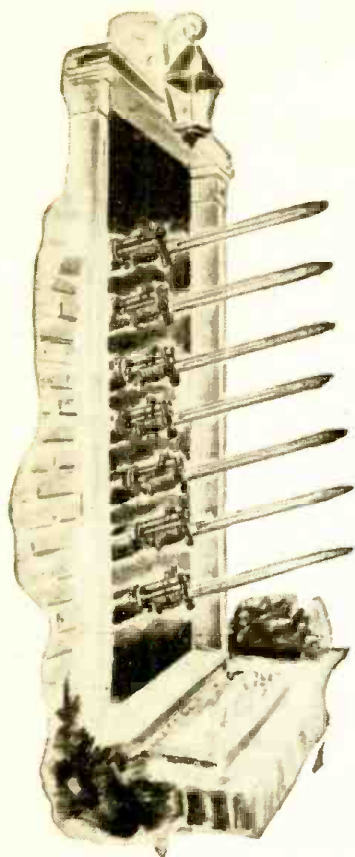

**T**HIS WAR can't be won on battlefields alone. One of the most critical campaigns of all must be waged right on the doorstep of every family in America.

This is the fight against higher prices and higher wages. It's a fight that *must* be won... or victories on battlefields will be meaningless.

It's like this. In America this year, our total income after taxes will be about 133 billion dollars. But there'll be only about 93 billion dollars' worth of goods to spend it on. If we all start trying to buy as much as we can, prices will shoot up.

As prices rise, people will ask for—and, in many cases, get—higher wages. That will put up the cost of manufacturing, so up will go prices again. Then we'll need another pay raise. If we get it, prices rise again. It's a vicious circle.

The Government has done a lot to help keep prices down. It has put ceilings on food and rent... has rationed scarce articles. But the Government can't do it all alone.

*It needs your help!*

Your part in this fight won't be easy. It will mean fore-going luxuries, perhaps doing without a few necessities. Tough? Maybe... but don't say that where the veterans of Italy and New Britain can hear you!

You *want* to do your part, of course. So do we all... farmers, laborers, white-collar workers, business executives. And the way to do your part *right* now is to observe the following seven rules for Victory and a prosperous peace...

**1. Buy only what you NEED.** And before you buy anything, remember that patriotic little jingle: "Use it up. Wear it out. Make it do or do without."

**2. Keep your OWN prices DOWN!** If you sell goods, or your own time and labor, *don't ask for more money* than you absolutely must! No matter who tries to talk you into asking more... *don't listen!*

**3. No matter how badly you need something... never pay more than the posted ceiling price!** Don't buy rationed goods without giving up the required coupons. If you do, you're helping the Black Market gang—hurting yourself!

**4. Pay your taxes cheerfully!** Taxes are the cheapest way to pay for a war! The MORE taxes you pay now—when you have some extra money—the LESS taxes you'll pay later on!

**5. Pay off old debts.** Don't make any new ones! Get, *and stay,* square with the world!

**6. Start a savings account.** Make regular deposits, often! Buy life insurance. Keep your premiums paid up.

**7. Buy War Bonds... regularly and often!** *And hold on to them!* Don't just buy them with spare cash you can easily do without. Invest every dime and dollar you don't actually NEED... even if it *hurts* to give those dimes and dollars up!

**Use it up... Wear it out.  
Make it do... Or do without.**



A United States War message prepared by the War Advertising Council, approved by the Office of War Information, and contributed by the Magazine Publishers of America.

# TRY THIS ONE!

## SIMPLE OSCILLATOR

Being in need of a simple oscillator, I looked through your issues for a schematic. I found one in last February's *Radio-Craft*, but its output circuit is poorly designed. About the only output that would be present would be the 60-cycle tone.

Instead of using that audio transformer, just eliminate it from the circuit, and wind on the 2½-inch form about 6 or 8 turns of No. 25 to 30 enamelled wire. Connect these to the output terminals, through two condensers, and ground one side of the pickup coil to the center tap of the tank coil.

Calvin C. Peters,  
White Hall, Md.

(The item in question appeared on page 311, February, 1943. The diagram as amended by Mr. Peters is given here. Coil L<sub>1</sub> was 30 turns of No. 20 S.S.C. wire (enamel will do) on a 2½-inch form. An old broadcast coil of any size is easy to obtain and sure to be correct.)

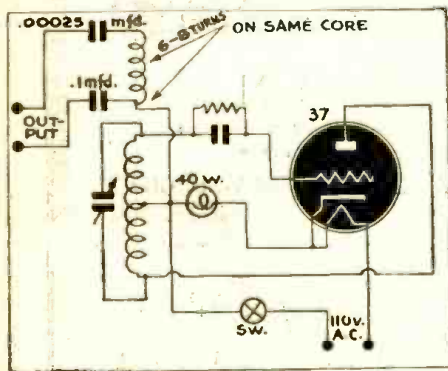

## INGENIOUS P.M. MIKE

I made this mike from a P.M. speaker out of an RCA kodak radio. The speaker is 3½ inches cone diameter by 1¾ inches in depth. I had two of these in my junk box, and though both seemed to be exactly the same, one was clear while the other was bassy.

The casing is an old bicycle lamp, and the stand is an old desk telephone, as can plainly be seen in the photo. I bought these for fifty cents from a junk shop. The P.M. fitted the case fine. It measured 3¾ inches inside diameter and 4 inches from front to back.

The glass, reflector and light socket were taken out, and a screen put in where the glass had been. This was soldered around the edges, and while soldering I made it bulge out a little. The output transformer of the P.M. speaker was then disconnected and put in the base of the telephone stand, which was stripped to the point shown in the photograph.

The mike sounded terrible in its case. So I borrowed an electric drill and made about seventy 3/16-in. holes, pattern style, in the back of the casing. This cleared up the tone.

Several methods may be used to hold the speaker firmly in the case. I used an

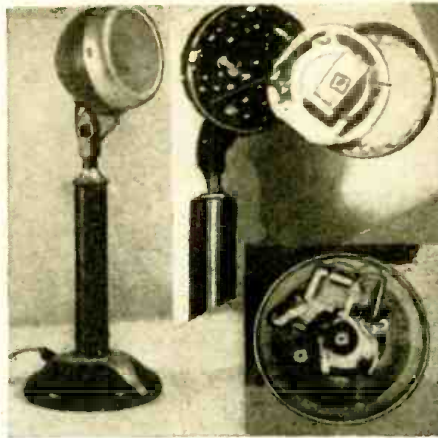

L-shaped piece of sheet metal fastened to the two tapped holes on top of the magnet. The bent part, which extended down parallel to the back of the speaker, was drilled, and another hole drilled through the back of the case. A bolt and bushings held it securely.

The casing of the microphone and one side of the voice coil should be connected together and attached to the grounded lead to the amplifier, or you will have hum. The leads from the microphone to the amplifier should also be shielded.

I tested this mike out at a dance in our school hall, interviewing about 30 of the boys and girls afterward. They all agreed that it was excellent.

P. Mcgregor,  
Montreal, Canada

## CHEAP TEST PRODS

Here is a pair of very inexpensive but remarkably efficient test prods. The points used were common, noninsulated, solderless phone tips. They may be sharpened to pierce insulation, corrosion, etc., if desired.

The handles were made from the cylindrical fiber insulators on cartridge type telephone fuses. Your local telephone office will probably give you a pair for the asking.

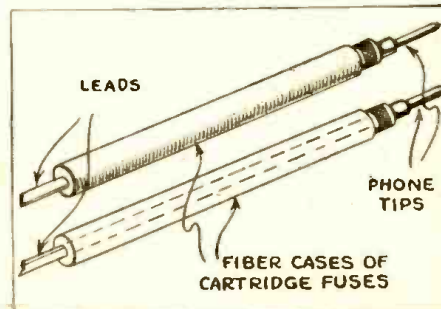

The leads were attached to the phone tips, threaded through the case, and the tips were forced into place as in the diagram.

Put another pair of phone tips on the free ends, and you have a set of test prods that will stand much abuse.

Chas. G. Sting, Jr.,  
Tiffin, Ohio

## GOOD HOOK-UP WIRE

Here is an original idea to not only save valuable metal, but also solve the problem of getting hook-up wire.

Many milk bottlers use iron wire, tinned with solder to seal their milk bottles. This wire, which is ordinarily thrown away when the bottle is opened, may now be put to good use.

The wire comes in lengths of about 8 inches, just right for most hook-up jobs in radios. The idea is to save the lengths of wire from the milk bottles, and slip it through thin lengths of "spaghetti" tubing. It then makes excellent hook-up wire, and is well insulated for high voltages. This wire may be used for all circuits in a set except for filaments, as in the higher voltage-low current circuits, the losses are very slight. Another good feature is the fact that this wire is already tinned with solder, not only preventing rust, but making the soldering job easy.

The cost of the spaghetti tubing to cover it is small, as only the thinnest lengths need be bought.

Servicemen and experimenters will find

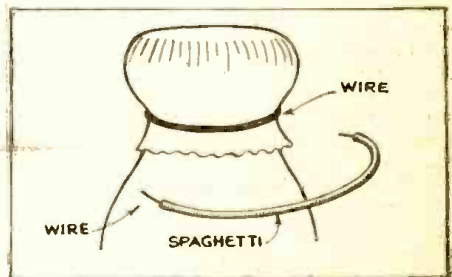

this a good way to use that wire, and can ask their friends to save it too.

In these days of shortages, we must learn to save every scrap of waste metal.

Winslow J. Williams,  
Brooklyn, N. Y.

## PILOT LAMP REMOVER

Noting the device for removing pilot lamps in the October issue, I have a pilot lamp remover which I believe to be better.

The rubber tubing takes a better grip on the lamp. It also has the advantage of flexibility—can bend to get into some of the tight places into which they put pilot lamps.

William Porter,  
Los Angeles, Calif.

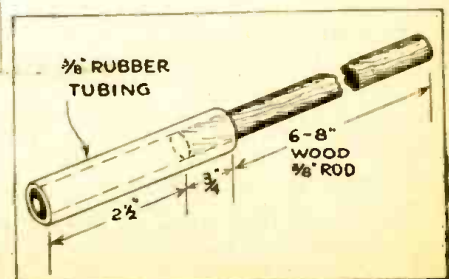

**ALL FM PROBLEMS SOLVED**

**Q**UESTIONS and Answers on FM were a featured part of the industry's recent convention in New York. So many of the questions proved unanswerable that the convention management entered into an agreement with FCC chairman, James Lawrence Fly, to "deal with them" as part of his address to the convention. Some of the "questions" and "answers" are printed below:

"First, Is it true that FM will replace AM and that eventually all AM stations will have to switch to FM? I found one very clear, convincing answer to this question. Mr. Eric Hoffenstatter of St. Paul, outstanding figure of the Northwest, heavily interested in the milling, lumber, and newsprint industries, who also puts out considerable pulp, says, and I quote: "This is one of the most serious questions facing the radio industry today."

"Here is another one: What is going to be done to suppress automobile ignition?"

"Well, I think you have to get right at the root of that trouble. I suggest that we require the automobile industry to shift to jet propulsion and set up a uniform, consistent speed of 186,000 miles per second, and radio ignition will never catch up with it."

"Can I get a construction permit for an FM station and wait until I am forced by competition in my town to begin construction?"

"Why, sure, sure. (Laughter) We will give you a paper, giving you the same sort of protection that the corner drug store gets from the government, assuring it against the entrance of a competitor in his vicinity."

"Am I cutting my own throat by building an FM station and letting my AM listeners get used to FM?"

"Yes, that is right (laughter), but why go to the trouble of building? Just cut your own throat anyway. That would probably be cheaper."

"I don't want to take too much of your time. I have the answers to all of these, though, if you come around."

"Here is just one more I think we ought to give attention to, for some of the people from the mountains. How can so-called dead spots on the side of hills removed from the transmitter location be taken care of?"

"I think the thing to do is to get out some bulldozers and take down the hill."

"That just illustrates to you what a little ingenuity can do in this business. (Laughter) And in that regard I do hope that we will all get together on this tremendous task that we have and stick together."

"Personally I more and more come to regard the purely formal and mathematical presentation of physical theories as a disguise and evasion of the real problems rather than as a solution of them. I have tried, in other fields, to show the incredible confusions, of which the whole world is now a seething example, that have followed from the invention by the Hindu mathematicians of negative quantities, and their justification from their analogy to debt. So that naturally I am not among those who can bow down and worship the square root of minus one."—*Frederick Soddy, in The Interpretation of the Atom.*

**HARRISON HAS IT!**

**FOR URGENT  
WAR WORK—**

**HALLICRAFTERS**

**RECEIVERS AND  
TRANSMITTERS**

**TUBES  
CONDENSERS  
RESISTORS  
TRANSFORMERS**

**AND THOUSANDS OF OTHER  
CRITICAL ELECTRONIC PARTS!**

**PURCHASING AGENTS—**

Call upon us for your high priority requirements of equipment and components for your production and development work.

**We usually have it in stock!**

**FOR THE  
HOME FRONT—**

**CODE PRACTICE SET**

Buzzer and key, heavily nickel plated, of single unit construction, mounted on wood base. Adjustable high frequency pitch. Complete with silk covered cord, in attractive box with code chart on cover. Works on one or two flashlight or dry cells.

**Postpaid—\$2.45**

**6L6G TUBES** First grade, \$1.37 ea. meter tested, 3 for \$3.75 fully guaranteed postpaid

**DYKANOL CAPACITORS**

Cornell-Dubiller oil filled, hermetically sealed metal cased condensers. 4 mfd. capacity. Rated at 220 Volts AC working, will stand over 600 Volts D.C. Ideal for amplifiers, receivers, power packs, etc. (Filtering action equivalent to 12 mfd. electrolytic but with better safety factor, longer life). \$2.25 (3. or more shipped postpaid).

**P. M. DYNAMIC SPEAKERS**

6 inch, with output transformer to match single plate of 8000 ohms **\$1.95**

(Not Postpaid)

Immediate delivery of the above items, without priority, while quantities last. Place L-265 or V-3 certification on your order. **SEND REMITTANCE WITH ORDER, TODAY!** (Money back if not satisfied.)

**HARRISON**  
RADIO CORPORATION

11 WEST BROADWAY

Phone WOrth 2-6276

NEW YORK CITY 7

**Here is Your Opportunity for—  
RADIO TUBES!**

**SIGN THIS!**

**CONSUMER'S CERTIFICATE**

I hereby certify that the part(s) specified on this order are essential for presently needed repair of electronic equipment which I own or operate.

Name .....

Address .....

Date .....

**WPB Limitation Order L-265 makes "Consumer's Certificate" mandatory with each order.**

We have over 100 different radio tube numbers available and coming in every day. Hundreds of satisfied customers all over the country are being supplied by Chicago Novelty Co., Inc. Join our list of preferred customers by writing today for those tubes you've been trying to obtain. **ONLY CONSUMER BUSINESS.**

**WRITE FOR OUR PRICE LIST!**

*Every order subject to prior sale.*

*All shipments express C.O.D.*

*Do not send check or money order.*

**ONLY MAIL ORDER BUSINESS ACCEPTED!**

**Chicago Novelty Company, Inc.**

**1348 Newport Avenue**

**Chicago 13, Illinois**

# ACCURATE



**UNFAILING** accuracy for maintenance and testing work in the field or service shop is one of the many features of the new General Electric line of SERVICE TESTING EQUIPMENT. Designed in the famous G-E electronic laboratories, this line offers a wide choice of portable apparatus for radio service men, service dealers and others.

G-E unimeters, tube checkers, audio oscillators, oscilloscopes, condenser resistance bridges, signal generators—all give you rapid, dependable service for testing radio and electronic circuits and component parts.

These sturdy, shock-resistant units are now in production primarily for the Armed Forces. But they may be purchased on priority if you are engaged in war work. After the war, of course, the full line will again be available to everybody... *Electronics Department, General Electric, Schenectady, New York.*



**ELECTRONICS DEPARTMENT  
GENERAL ELECTRIC CO.**  
Schenectady, N. Y.

Please send, without obligation to me, the General Electric Testing Instrument Catalog, R-1 (loose-leaf), for my information and files.

Name \_\_\_\_\_

Address \_\_\_\_\_

Company \_\_\_\_\_

**GENERAL ELECTRIC**  
Electronic Measuring Instruments

# A Serviceman to His Son

By EUGENE M. CONKLIN

Dear Son:

Radio repairmen note that spring is here. Not that this season of the year means a darn thing. If anything, the sight of "Old Sol" shining outside, while friend radio-man is stuck inside, gives everyone concerned a touch of the well-known "willies."

But, nevertheless, we repeat "Spring is here," and that brings up the question of the automobile radio service. Last year, due to a combination of weather and rationing, the average car owner put his family jalopy up for the winter months but now that a war-worker's conscience is his only guide and he may use up his precious allotment of gas as he sees fit, automobiles are back on the highway again. Almost every war-worker is a "fishing fan" and is determined to hoard enough gas for one or two outings. Quite naturally he wishes the radio to perk as he perambulates along the highway.

Which means that your old father, as well as many of my other service colleagues may expect to be swamped with automobile radio repair jobs. The question of tubes is an interesting one. It is all I can do to maintain a stock of home-radio tubes without considering the automotive types. However, on talking with my radio-service friends, I find that most of them have a considerable number of auto-radio tubes left over from last season. Vibrators and other car radio components are a horse of a different color. While the stock is plentiful, wholesalers have assured me, this supply may not hold out if automobile radios require servicing in huge quantities.

The average car owner is bringing in his crate expecting "while-you-wait service." It is hard to refuse this request unless you plan to run a garage and store the car until you get around to work on it. One serviceman in our locality takes this effective method of eliminating such a headache.

He arranges with a local garage to allow the car owner to store it there until the serviceman can get a chance to come over and look at it. This may require 24, 48 or even 72 hours before our serviceman can leave his shop. But it is much more convenient to the serviceman than dropping everything and rushing to handle one small — or even large — radio job.

Several other servicemen are putting aside certain hours a day for car work alone, turning down all auto radios not brought in during those periods. The best time—from all

indications—would seem to be between 7:00 and 10:00 P. M. Many servicemen are servicing nothing but car radios during the evening and refusing to touch the things during daylight hours. In this way, both car-radio and home-radio owners are happy. The service man is happy because he would prefer working on auto radios to being on home calls at night.

The delivery question is being handled by our rural friends through having farmers act as deliverymen. These farmers have to use their trucks to deliver or pick up milk cans daily and are perfectly willing to accommodate the serviceman by adding radios to their daily load.

Most of our rural radiomen are working in defense plants on day- or night-shifts and spending another full 8-hour shift on radio repair work. The rural serviceman can not refuse to handle clocks, fans, toasters, and the like. The farmers depend upon these electrical appliances, and whether friend serviceman likes it or not he must combine electrical and radio servicing.

Worry No. 1 to servicemen in resort regions is the expectation that tourist trade this summer will be tremendous. Many war workers are being given vacations now that the rush of war work has somewhat slackened. Other workers have not had vacations for several years and intend taking same this summer. Invariably our old friend the walkie-talkie portable radio accompanies said workers on their vacations, and it is a well-known fact that these portables develop the "jitters" several times during the summer period.

You will be interested to know that black-outs and air-raid tests have decreased tremendously in the rural regions. This takes a load off our rural serviceman's aching back. Formerly he might

## UTILITY AND PLEASURE

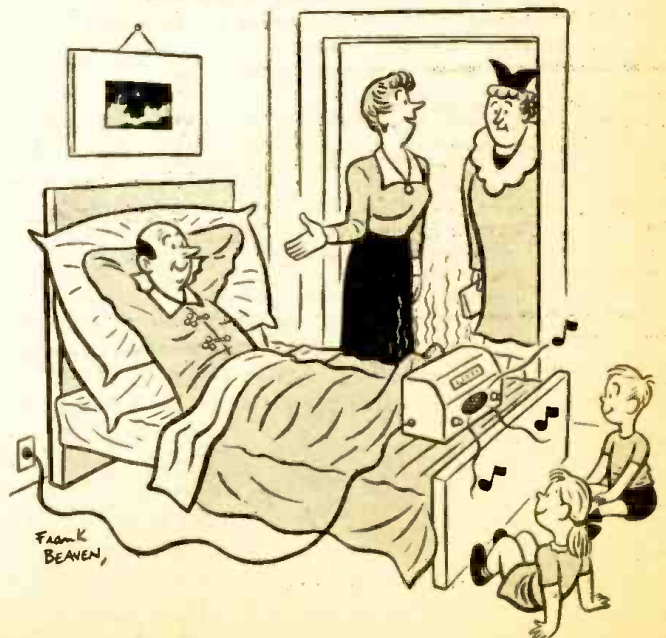

"My husband suffers from cold feet!"

RADIO-CRAFT for APRIL, 1944

expect to spend one or two nights weekly testing the local air-raid system and operating it in time of simulated air-raids.

Leaving the rural scene, the spot news of the Spring Season concerns city folks like myself. Several service shops are working out a half-and-half combination of house and shop activity. When a phone call comes in concerning a set the serviceman offers the customer his choice of house or shop service. House service is at double the usual rate, just as the doctor charges a higher figure for making a personal call on a sick patient. Many customers are willing to pay the increased tariff because they desire speedy service, but in the long run, many a set-owner will hesitate before demanding house service if they know that their expenses will be considerably higher. In that way the serviceman does not have to refuse house calls, and at the same time the increased cost helps compensate him for the time lost from the service bench.

Winding up my commentary on "Spring", you will be interested to note that at least one serviceman in my territory is taking a two-weeks' vacation during June or July and informing his customers, via the newspaper, of his decision. He is not attempting to keep the shop open but has arranged with several of his service competitors to handle his work during his siesta. Formerly servicemen have hesitated to hand over their service customers to competitors, even for a short period, for fear they will never see said customers again. But this particular friend of mine feels that after his absence from duty he will be able to plunge full-tilt into work and accomplish far more for having shaken the cobwebs from his brain.

Some of our servicemen are talking about arranging a cooperative schedule where each serviceman takes a week shutting the shop up entirely and turning over that week's business to one of the other cooperating servicemen. Because it is a cooperative move, no one serviceman would lose since each would share a certain amount of new business brought to him through the closing of another shop in the movement.

Well, so long, for now. Take care of yourself. Will write you soon.  
YOUR LOVING DAD.

## SALLY THE SERVICE MAID

(Continued from page 413)

draw lower cathode currents."

"Right!" His smile pleased her tremendously. "So we know the current through our two fields will not be the same. But let's assume it will be—only to make the mental arithmetic easier. Shall we? And let's make the absurd assumption that 100 mils flows through our two fields. Then, what is the voltage-drop across each field? And 100 mils is one-tenth ampere."

Sally's brow became corrugated. "Let's see—Ohm's Law . . . in the 450-ohm field we have one-tenth times 450, or 45-volt drop. And, in the 3,000-ohm field—"

"—Our voltage drop will be higher, in these impossible figures, more than the total voltage! But please continue."

"Well, one-tenth amp. times 3,000 ohms—why, that's a voltage drop of 300 volts! Nearly three times our actual voltage!"

"I know; but this is what happens when we do too much assuming."

Sally grinned. "I have learned a great deal. And thank you, very much, Corporal Dan Bryner . . . Sir."

"Only officers, Miss Mason, are addressed as Sir."

An awkward silence followed, until Dan said: "Let's now try a speaker with a 450-ohm field."

A long search failed to unearth the correct speaker. "One moment," he said. "The field in the old speaker is okay, isn't it? Well, let's use it."

Dan removed the pole pieces from the two speakers; installed the old field in the new speaker, carefully aligning the voice coil. Then he marked the field they had no present use for and put it on the shelf.

The Emerson warmed to operating temperature and performed beautifully. Sally was ill at ease. She removed the money Dan had given her, from the cash drawer: "I do hope you will, please, at least accept that Antenna Coil as a—er—well, you know."

"Why?"

Sally blushed prettily.

Dan picked up his package, waved and said: "See you next month."

Sally shook her head. "Such a nice boy! And the Palace has such a perfectly swell movie, tonight!"

An Allied Nations Standards Body is a recent suggestion of such organizations as the American Standards Association and the British and Canadian parallel organizations.

There has already been a tendency toward some standardization in radio apparatus, due to the pre-eminence of American parts and especially tubes, throughout the world. Thus Philips in Holland manufactured a full line of standard American types before the war, and some of the recent British sets have used RCA tubes.

# Learn RADIO ELECTRONICS

quickly • easily AT HOME

**THE SIMPLE A-B-C DeFOREST WAY!**

**You GET A LOOSE-LEAF LESSONS**

DeFOREST'S TRAINING includes 90 loose-leaf lessons, prepared under the supervision of one of the world's foremost Radio authorities, Dr. Lee DeForest—inventor of the audion tube which has helped make modern radio possible . . . holder of over 300 radio patents . . . and often called "Father of Radio."

**You CAN BUILD 133 FASCINATING EXPERIMENTS WITH THIS EQUIPMENT**

**You SHOW B MOVIES AT HOME**

You get the use of a genuine DeVry 16 mm. motion picture projector and films which provide the easy to understand, highly effective modern visual training—a method used today to train better and faster in war plants and military service. Radio principles come to life! . . . you see electricity in action, electronics made CLEAR the EASIER DeForest way. Get DeForest's BIG FREE BOOK. "VICTORY FOR YOU"—a key to a good pay job in the electronics industry, to a business of your own or to better military rating and pay. Act now. Mail the coupon today!

**Send for Free Book!**

**FOR A BETTER OPPORTUNITY TODAY— PLUS A BETTER POST-WAR FUTURE**

Get into Radio and Electronics—a billion dollar OPPORTUNITY FIELD OF TODAY that promises such a THRILLING POST-WAR FUTURE. See how you may get ready for a GOOD JOB . . . or a BUSINESS OF YOUR OWN . . . BETTER PAY and HIGHER RATING in military service. Read how DeFOREST'S prepares you for your start in Radio-Electronics quickly, easily, in your spare-time at home—the simple "A-B-C" DeFOREST'S Way. You'll find all these answers, and more, in DeFOREST'S big, illustrated book, "VICTORY FOR YOU!" Write for it today. It's FREE.

**You Get This Exclusive 3-WAY Combination of Radio Training Advantages**

You READ . . . you SEE . . . you DO! (A) You get well-illustrated lessons prepared the modern loose-leaf way to help keep your training up-to-date. (B) You get real, practical RADIO EXPERIENCE from eight big kits of standard Radio parts and assemblies. (C) You get the use of a 16 mm. MOVIE PROJECTOR AND 12 TRAINING FILMS. You 8-E-E "hidden actions" of Radio circuits from fascinating, easy-to-learn-from ACTION MOVIES. You get what you think are the major Radio training aids—AT HOME!

**You GET EMPLOYMENT SERVICE**

DeFOREST'S Training includes an effective EMPLOYMENT SERVICE that has long-established contacts with many companies employing trained Radio men. You enjoy this valuable assistance once you are trained. DeFOREST'S is affiliated with the DeVRY CORPORATION—well known manufacturer of Motion Picture Sound Equipment.

**You WORK AT HOME WITH PRACTICAL EQUIPMENT**

You enjoy a "Home Laboratory." You get valuable Radio experience by building modern Radio circuits that operate; also, "Electric Eye" devices, Light Beam Transmitter, Public Address System, Wireless Microphone, etc. 133 fascinating experiments in all—in spare time, at home.

## DeFOREST'S TRAINING INC., Chicago, Ill.

DeFOREST'S TRAINING, INC.  
2535-41 N. Ashland Ave., Dept. RC-3,  
Chicago, U. S. A.

Please send me—FREE and WITHOUT OBLIGATION—illustrated book, "VICTORY FOR YOU," showing how I can prepare for Radio with your Home Movies and Laboratory Kits.

Name  Age

Address

City  State

(Please help our country save paper. Do not reply unless you are 17 or over)

**RADIO EQUIPMENT HINTS**  
**SYLVANIA**  
**SERVICEMAN**  
**SERVICE**

by  
**FRANK FAX**



"RADIO EQUIPMENT HINTS" describes testing equipment so important to every radio man's service bench. Hints on how to use this equipment will save you time in tracing and locating receiver troubles.

There are 59 pages of clear information from radio tube headquarters. The volume is liberally illustrated with photographs, circuits and graphs.

Read over the subjects in the Table of Contents, reproduced below:

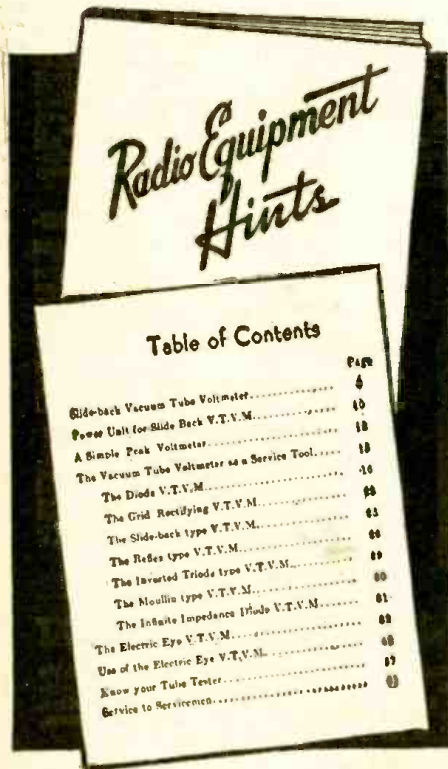

This is the second of the new Sylvania "Hints" series.

"Radio Equipment Hints" is FREE. If your jobber does not have copies, write to: FRANK FAX, SYLVANIA, EMPORIUM, PA.

**SYLVANIA**  
**ELECTRIC PRODUCTS INC.**  
 RADIO DIVISION • EMPORIUM, PA.

# Future Radio Rockets

## May Be World's Most Terrible Weapons

**T**HE recent reports of radio-controlled, rocket-propelled explosive missiles mark the first practical appearance of an instrument, which—no matter how imperfect, ineffective or inefficient it may be at present, is destined to be the most dreadful weapon ever devised, and perhaps the most terrible weapon that ever will be invented.

There are many who are contemptuous of the rocket as a serious weapon. Their attitude is based, no doubt, on the fact that it has been known for a long time. Never, up to date has it been able to perform all that was expected of it.

Such an attitude is dangerous, for should the rocket suddenly appear in a form commanding respect, it will be much too late to do anything about it. It is not unusual in technical matters for the perfection of a device to be held up until something else, apparently quite extraneous, has been developed. For example, the modern machine-gun was impossible until the brass cartridge case could be manufactured in quantities with precision, and that depended on development in precision engineering, particularly in presswork.

In the case of the rocket, early experiments and even practical uses, up to recently were no more than demonstrations that rocket-propulsion does actually work. That form of propulsion has not yet been developed in practical uses to anything like what is possible; for instance, explosive propellants can be used much more efficiently in a gun than in a rocket. The full power of the rocket as a weapon could not be attained without some of the most recent scientific developments, particularly in radio.

### ROCKET AND TARGET SPEED

The maximum speed of targets on land and sea may be taken at 60 miles per hour (88 feet per second), and if the average velocity of gun projectiles is taken as 1,500 feet per second, then the latter is about 17 times faster than the former. Taking the average speed of modern airplanes as 375 miles per hour (550 feet per second), the projectile is less than three times faster, and if the airplane is at a high altitude the projectile may be less than twice as fast, hence the comparative immunity of aircraft. To restore the ratio of 17 times relative to aircraft, missiles must have a velocity of 9,350 feet per second.

Rockets with good directional stability may therefore deprive aircraft of its present immunity without using radio-guiding. With such guiding, even at velocities of 1,500 to 3,000 feet per second, aircraft would have little chance of escape, that is, if the radio control is really effective. The radio-guided rocket-propelled explosive missile is indeed a super-weapon, a spear which can be thrust into any part of a country's anatomy at will and against which there can be no adequate defense other than counter bombardment with the same form of missiles. It is a delusion to think that some ready antidote can be found, comparable to degaussing against magnetic mines, which will render the radio-guided missile ineffective. No such antidote has been found for a bullet in hundreds of years.

Equally useless is the wishful thought—based on the crazy antics of unstabilized experimental rockets—that rocket-propelled missiles will be as dangerous to the senders as to the receivers, for with proper radio control such erratic behavior disappears. The idea that one need only switch on a radio transmitter to take over the control of an enemy's missiles and thus turn them on him or render them innocuous is absurd. In this war radio is used universally, even in the front line, giving plenty of opportunity for radio tricks, but how effective have such tricks been? Ordinary broadcasting has not been seriously impaired by jamming, or even the imposition of the death penalty.

### MANUAL CONTROL IMPOSSIBLE

The present is not time for discussing the principles of or systems for radio-guiding high velocity missiles. Certain it is that the latest developments in radio, radiolocation, remote control and automatic devices, will be required. Radio controls such as have been used for steering model airships around a theater, or target airplanes, are out of question. It is difficult enough for a pilot sitting in a high speed airplane to guide his craft so that it will ram any given target. The idea that any man by his own manipulations of radio apparatus can accurately guide a missile he cannot see and the immediate position of which can only be indicated instrumentally when that missile is travelling at anything between 1,500 and 7,500 miles per hour is ridiculous. The speed of human reactions and of human reasoning is far too low. The actual control while the missile is in flight must be entrusted to automatic apparatus, apart from secondary controls which are



"Could you put a fresh vacuum into it?"

within the powers of human manipulation.

The perfected radio-guided rocket-propelled missile has not appeared yet, but it is something to be treated with profound respect. Delay in taking steps to meet it will be, to say the least, most unwise. There is no reason why this country should not perfect the new weapon first, but it is not one of these cases where the spade-work can be left to others, with the idea of taking it up when it has been fully proved. The position is more like that of two men grabbing for the revolver on the table. The one who gets hold of it first will be the sole survivor. An obvious first step is to find and obliterate places where the weapon is being developed or manufactured for use against this country, and the last step, necessary if others fail, is armor protection and plenty of it, as in deep shelters and acceptance of such changes as are necessary in becoming permanent troglodytes.

### A PEACE-MAKER?

In one respect the new weapon, dreadful as it is, may be of the greatest benefit to man, by producing the final stalemate in war. The service personnel required to man the defenses of a country, that is, the launching cradles, will be such a small number that any country may be permanently mobilized. Its power in war will depend on its stock of missiles and the rate at which it can produce them.

The stock of missiles will be the unknown or uncertain factor, and a country can be at war in full blast in a matter of hours if not of minutes. One false move by any nation and all hell is likely to break loose in less than no time.

Under such conditions ideas of conquest or stealing a march on other countries are out of question, for the situation would be like that of a small village in which the occupants of every house are fully armed, in position, with rifles aimed and all suffering from trigger-itch. Under such conditions life could not go on without full mutual confidence and understanding. It would be obvious to every country, whatever its lust for power and dreams of conquest might be, that there were far more chances of gain in arbitration than in the certain destruction which would inevitably accompany armed combat. When that happens the radio-guided rocket will take its place alongside the passenger-carrying airplane as a means of rapid, automatic transport for mails and perishable or valuable goods.—*Aeronautics (London)*

### ELECTRONICS OLD IN 20'S

THE forecasters have had something of a field day in the field of industrial electronics. Overlooked entirely is the fact that most of the uses suggested as new have been available since the middle '20's. In fact, vacuum tubes were then heat treated by exactly the same methods and type of apparatus that are being suggested today as something of a cure-all for many industrial processes.

During the depression we had ample time on our hands, and worked in the laboratory with many of our customers in treating their products by electronic methods. During that period we baked hams, kiln-dried lumber, cured plastics, dried movie film, cemented shoes, together with thermo-setting materials, dehydrated tobacco for export, killed vermin in grain, foodstuffs and candy, and a number of others. All but a few were technically satisfactory. And finally a mortician asked us to sterilize a corpse in lieu of embalming. We believed it would work, but declined the opportunity. However, almost none of these resulted in actual

production applications. Some were competitive with existing methods, some few gave no better results. However, all the potential purchasers had a common reluctance to put their money on the line for the initial cost of the installation during those gloomy days of the depression.

But many new and justifiable uses are being tried, are economically sound and will be put into use just as soon as critical material can be released by WPB.

Probably the outstanding electronic achievement of 1943 was the reflowing of tin, which within a year's time became the standard method of most of the steel mills manufacturing tin plate. Low frequency transmitters of some 600 kilowatts capacity are coupled to the tin line and reflow the dark gray, porous electroplated sheet into bright non-porous commercial tin plate. The method saves about 65 per cent of the tin

formerly necessary for making tin plate. And, because of the shortage of that critical metal, the method was rapidly adopted.

To name just a few of the outstanding applications on which development work is well along: the molding of plastics, annealing of electrical steel, bonding of plywood, brazing and soldering, hardening and tempering of metals, production of alloy steel, inspecting for porosity on metal sheet and castings, dynamic balancing, vibration fatigue of materials, remote power line operation and metering and high speed X-ray inspection of castings and forgings.

There are also many other uses which have proved out in the laboratories and are ready for post-war markets.—*Walter Evans, Vice-President in charge of Radio, Westinghouse Electric and Manufacturing Co., in a speech to the Radio Executive Club of New York.*

Get into

RADIO

ELECTRONICS

TELEVISION

now!



Prepare for the future. Get ready now for an interesting career in Radio, Electronics and Television, the gigantic industry now known in its entirety as R-A-D-I-O-N-P-C-S. The Field of Today and Tomorrow!

### SHOP METHOD HOME TRAINING

BY A REAL, ESTABLISHED TECHNICAL TRADE SCHOOL GET READY FOR YOUR OPPORTUNITY... IT'S HERE! Radio technical men are needed everywhere; afield in action, and at home in industry! Trained men are needed in the Army, Navy and Air and Signal Corps, Government Defense Service and Civilian fields. Now, in answer to repeated demands for Trained Radio Technicians, National Schools has extended its famous Shop Methods so you can qualify right at home. You can quickly prepare to be of greatest service to your country and yourself. Yes, right at home, in your spare time. National's time-tested plan of Home Training will definitely establish you, in a short time, so you can hold a good job in this fascinating field. Furthermore, you become equipped for an even bigger career in the years of reconstruction after the war.

### BIG OPPORTUNITY FOR NATIONAL GRADUATES

For 38 years National Schools has trained ambitious men for Top Pay trades. Squarely behind you are the modern, completely-equipped Training Shops of National where we pre-test and prove every instruction sent to you. Training in your home is comparable to actual laboratory practice.

### GET ON THE TECHNICAL FRONT

Unique training facilities give you Home Training based on Resident School Shop principles—methods not available from any other source, to our knowledge. You'll be amazed when you receive our Free Lesson and full details. MAIL THE COUPON TODAY!

### FREE LESSON and OPPORTUNITY BOOK

Mail Coupon for new Opportunity Book which gives full details about the big future of Radio Electronics and Television, and how you can qualify. Also, Free Lesson to demonstrate how easy you can learn. No obligation.



— THE START TO SUCCESS COUPON

More than 50,000,000 Radios in use. More than ever before, because of the shortage of new equipment, they must be serviced. Over 800 Broadcasting Studios employ trained Radio Technicians. Electronics, a whole new industry, based on Radio principles, is growing at an amazing pace. Television, too, will soon need its own corps of trained men. Get READY NOW. Here is your opportunity to get into a permanent field of fascinating and profitable employment.

### MILITARY SERVICE

Prepare for Radio Service in Army and Navy. In U. S. Gov't. service you install, operate and maintain most technical equipment such as secret ultra-high frequency apparatus to locate airplanes, submarines, etc. Get promotion in rank and increased pay almost from the start.



### KEEP PRESENT JOB WHILE LEARNING

Regardless of previous education or age you can Train for Radio. Continue your present job. Earn while you learn. If subject to Military Service, all the more important that you get pre-training.



### RADIO EQUIPMENT INCLUDED

You receive modern experimental apparatus.

## NATIONAL SCHOOLS

Los Angeles California  
ESTABLISHED 1905

### MAIL OPPORTUNITY COUPON FOR QUICK ACTION

National Schools, Dept. 4-RCR (Mail in envelope or paste on penny postal)  
4000 So. Figueroa, Los Angeles 37, Calif.

Mail me FREE, without obligation, one Lesson and Opportunity Book, with full details about how I CAN become a RADIO Technician.

NAME ..... AGE .....

ADDRESS .....

CITY ..... STATE .....

Include your zone number.

# OHMITE "DIVIDOHM"

*Adjustable  
Resistors*

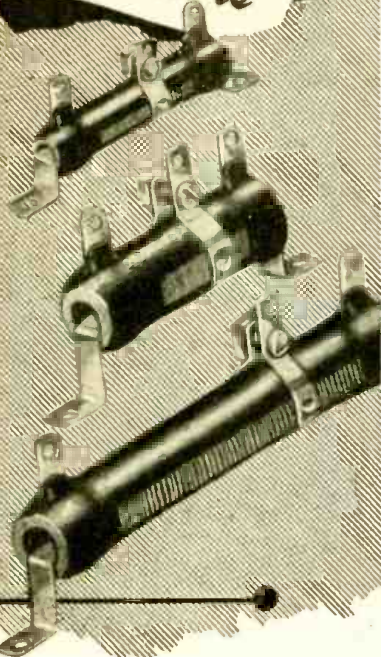

Ohmite "Dividohms" make ideal voltage dividers by the use of one or more adjustable lugs. Also handy for obtaining odd resistance values, for adjusting circuits, and for use on equipment which must be set to meet various line voltages.

The "Dividohms" are wire wound on ceramic cores, and vitreous enameled. A narrow strip of the wire is exposed for contact with the adjustable lug. Every turn of wire is securely held against shifting. Stock units made in 10, 25, 50, 75, 100, 160, 200 watt sizes—wide range of resistance values.

Write for Free Catalog 18

Ohmite Manufacturing Co.

4894 Flournoy St., Chicago 44, Illinois



### Handy Ohm's Law Calculator

Helps you figure ohms, watts, volts, amperes—quickly, easily. Solves any Ohm's Law problem with one setting of the slide. Send 10c in coin to cover handling, mailing. (Available in quantities.)

Be Right with OHMITE  
RHEOSTATS • RESISTORS • TAP SWITCHES

# "WOODYARD" WINDER

*Screwy as this coil winder may appear, it is entirely practical, and has features not often found in such simple jigs.*

By A. HEISLER

ALL parts may be had from any well-stocked five and ten cent department store. In the present case a hardwood bread board 10 inches by 14 inches in size and approximately  $\frac{3}{4}$  inch thick was purchased. From the 10 inch by 14 inch piece saw two pieces 2 by 14 inches, leaving your base 6 by 14 inches.

These two are for winding posts. As your posts are  $1\frac{1}{2}$  inches long you will saw off two small blocks that can be used to brace the posts on the board. Clamp these two posts together carefully and on a center line 2 inches from the end bore a hole through them  $\frac{1}{8}$  inch larger than the rod you will use for winding shaft, which in this case was a  $\frac{3}{8}$  inch hole, as a  $\frac{9}{16}$  inch shaft was used. Remove clamp and carefully line up with this hole an empty magnet wire spool, in which a hole is bored the same size as the shaft hole. Glue or fasten on with a few small screws. This spool is to keep the handle some distance from the device and also to keep it from wobbling while working it.

The front of the board has two posts fastened at the side. These are 8 inches long, 2 inches wide and  $\frac{3}{4}$  inch thick. Bore a hole  $\frac{7}{16}$  inch in diameter  $3\frac{1}{2}$  inches from one end (the bottom) and 3 inches from center of this hole make another. These holes are for dowel rods of  $\frac{3}{8}$  inch diameter to allow the wire holder to slide on. When the base is done you will have two long posts and two short posts mounted.

The frame for holding the spool of wire is made of  $\frac{3}{4}$  inch thick board. Two pieces  $6\frac{1}{4}$  inches long and  $2\frac{1}{2}$  inches wide are clamped together and  $2\frac{1}{2}$  inches from the bottom, on the center lines, bore a  $\frac{7}{16}$  inch hole and 3 inches further another. The bottom piece is  $4\frac{1}{2}$  inches long and  $2\frac{1}{2}$  inches wide. Now  $1\frac{1}{2}$  inches from the bottom, fasten one wing of a cupboard spring hinge on the inside of one of the pieces with bolts 8-32 or larger. On the other wing fasten a small board, slotted to straddle the  $\frac{3}{8}$  inch dowels holding the wire holder. This piece is  $3\frac{3}{4}$  inches long, 2 inches wide and  $\frac{1}{4}$  to  $\frac{3}{8}$  inch thick, and will be considered as the pressure plate. An idler plate,  $4\frac{1}{4}$  inches long,  $1\frac{1}{2}$  inches wide, with  $\frac{7}{16}$  inch holes in it, is made. This plate must be unusually free on the dowels. Across the top of this frame are fastened two small rods on which is mounted a free running, grooved wood pulley or wheel, over which the wire is led to the coil form. These two rods act as spacers and stiffeners for the top.

The spring from an ordinary rat trap was used to apply tension to the pressure plate, and a hook provided to hold it away from the idler when required, as shown in the photo.

The winding shaft, in this case  $\frac{9}{16}$  inch, should turn freely in the post holes and be several inches longer than the base.

Not having any cones for the winding shaft the writer purchased two wood funnel-shaped whistles at the five and ten and cut the whistles off the small end and made the hole large enough to slide over the shaft easily. Now take an old magnet wire spool, cut in two pieces and taper the body to fit into the larger end of the cones and glue, and with screws also. Fasten this

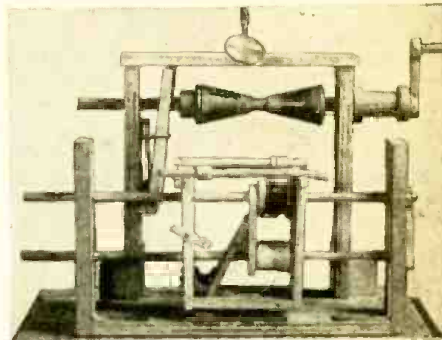

securely in the cone, then face the collar of each piece of spool with tin so as to give smooth bearing and prevent undue friction and wear. A piece of metal should also be placed inside one winding post.

## SWITCH TESTER SAVES TIME

BY suggesting a fixture for electrically and mechanically testing a signal selector switch used in radio transmitters in production, Mrs. Catherine Marchewka, a tester at one of General Electric's Works, has eliminated the possibility of a defective switch going into the final assembly before being detected. The Company paid Mrs. Marchewka \$250 for her suggestion.

The test fixture is simple and foolproof. As shown in the sketch, the switch is mounted on a vertical backboard and is coupled to an extended shaft from a model switchboard. By turning the switchboard selector to each of its three positions, the switch is checked electrically by observing proper combinations of six lights mounted on top of the backboard.

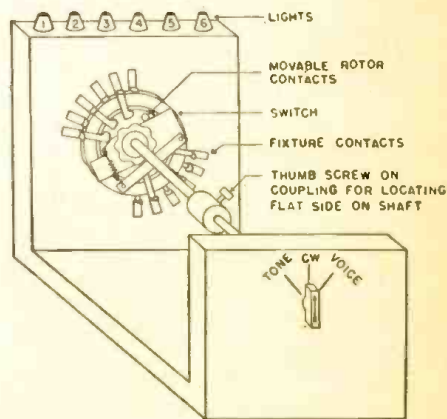

FIXTURE FOR TESTING SIGNAL SELECTOR SWITCH

The switch controls a series of contact points in each position, and this arrangement permits all of them to be checked quickly and accurately. In the "Tone" position of the selector, lamps 2, 3, 4 and 6 light; in the "CW" position, 3 and 5 light; and in the "Voice" position, 1, 4, and 6 light. If one or more of the lights in a sequence fail to go on as they should, the switch is rejected. Mechanical action of the switch is also checked while it is in the fixture.



## TWO-TUBE FM RECEIVER

(Continued from page 410)

we find that we have achieved our goal—a one-tube super-regenerative FM receiver. The circuit of this set appears in Fig 3, complete with an audio output tube.

Some experimenting may be necessary with the connections on the windings of the two audio transformers to make sure that the outputs from the two detectors oppose each other. It may also be necessary to provide individual regeneration controls for each detector in case the output of one proves to be appreciably greater than that of the other. Such troubles should not appear, however, if reasonable care is employed in construction.

Alignment of the set is simple. Tune in an AM signal on the high end of the band, set the tuning condenser at or near minimum capacity and adjust one of the 3-30 mmfd. trimmers to bring in the signal on that detector. Adjust the trimmer accurately to give maximum output as shown by an output meter, indicating that the signal is tuned in exactly. Then tune the other trimmer until the signal is received on the other detector. This will be indicated by the meter reading falling to 0 or to a minimum very near 0. The trimmer should then be backed off until the meter just returns to the peak previously shown by it. The receiver will now receive FM signals. To bring it to peak efficiency, the FM transmitter already described should be modulated with a constant audio tone and the signal picked up on the receiver and tuned in for maximum output. The last trimmer mentioned above may then be adjusted to give maximum output and fidelity. This may be done by ear; with an output meter to indicate volume in conjunction with aural testing of the fidelity; or with an oscilloscope, which will indicate both output and fidelity simultaneously.

FM has a great part to play in commercial wireless communications. It is the author's opinion that amateur activity in this field will also grow steadily, especially when the end of the war removes the restrictions under which all experimenters are now suffering. And for the amateur of today, it is my hope that the ideas in this article may provide an incentive to pull out the old junk box and make a start toward some really reliable WERS sets.

HALLICRAFTERS ★ HALLICRAFTERS



### COMPLETE STOCKS

I have large stocks of receivers available for immediate delivery on priority and the following parts without priority: meter rectifiers \$1.95, meters, tubes, transformers, resistors, condensers, panels, chassis, etc. Your orders and inquiries invited.

## LET'S ALL PITCH IN!

WE CAN all help win this war by selling our government the communications receivers and equipment they need quickly and in sufficient quantities.

That is the reason I pay *highest cash prices* for used communications equipment.

When this war is over you will be in the market for new equipment and by taking advantage of my offer to purchase your present equipment at highest cash prices you will be in a position to buy new and better equipment than you now own.

Write, telephone or telegraph me description of your used communications receivers, transmitters and parts of standard make; you will be paid cash immediately without bother or red tape. I am particularly interested in *Hallcrafters*.

I also have a store at 2335 Westwood Blvd., West Los Angeles, Calif.

**Bob Henry, W9ARA**  
**HENRY RADIO SHOP**  
BUTLER, MISSOURI

"WORLD'S LARGEST DISTRIBUTOR OF COMMUNICATIONS RECEIVERS"

## FOUR VOLTAGES FROM ONE GENERATOR

A NEW and unusual dynamotor, designed by Westinghouse and now used in large quantities for military applications, provides four closely regulated voltages, rated with respect to the common terminal: -150, +14½, +300 and 450 volts, obtained across the 300- and 150-volt windings. The machine requires four separate commutators—thus, the problem of taking connections to outer commutators through the inner commutators had to be solved. Ordinarily, output voltage of a dy-

namotor bears a fixed relation to the supply voltage. In this case, however, all output voltages are held constant for all normal input-voltage variations. This is accomplished by means of a regulator field which weakens when the input voltage rises and strengthens when the voltage drops; the regulator utilizes a separate core. The complete armature has four commutators, two cores and four windings—the total diameter is 2.8 inches and the length is 11 inches.

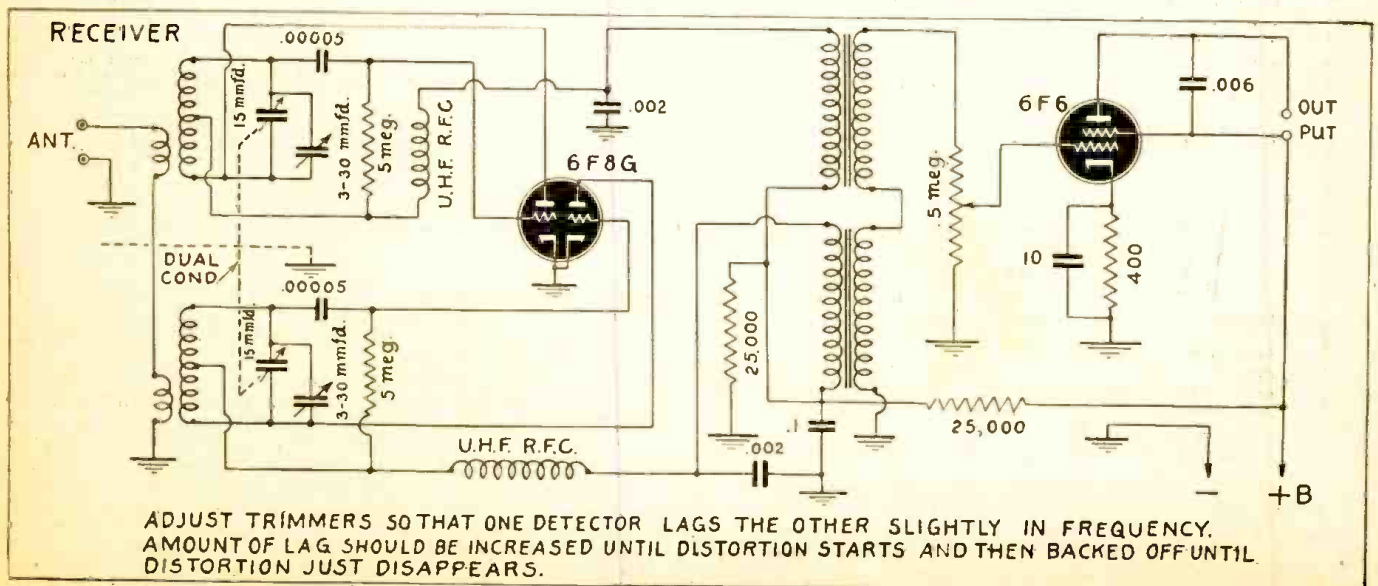

Fig. 3—Complete schematic of the simplified FM receiver. Transformer secondaries may be connected to the input of any amplifier.

*Centralized... to  
Serve You Efficiently!*

**LARGEST and MOST  
COMPLETE STOCKS**  
of RADIO  
AND ELECTRONIC  
EQUIPMENT  
*Under One Roof*

**FREE**  
most complete  
up-to-date  
**BUYING  
GUIDE**



**REPAIR and  
REPLACEMENT  
PARTS  
AVAILABLE  
without priority**

*Save time—  
Call Allied first!*

The world's largest stocks are centralized in this single arsenal of supply. Over 10,000 items from all leading manufacturers... for the Armed Forces, Radio Training, Research Laboratories, War Industries and Service Replacements. Our experienced staff helps speed delivery. Save time—simplify procurement—call **ALLIED first!** Thousands do.

Write, wire or phone Haymarket 6800.

**6 Radio Books for 75c**

Dictionary of Radio Terms. No. 37-751 **10c** Radio Data Handbook. No. 37-754 **25c**

Radio Circuit Handbook. No. 37-753 **10c** Radio Builders Handbook. No. 37-750 **10c**

Radio Formulas & Data Book. No. 37-752 **10c** Simplified Radio Servicing. No. 37-755 **10c**

All Six Books No. 37-799... **75c**

*Write for Quantity Prices*



**ALLIED RADIO CORP., Dept. 2-D-4**  
833 W. Jackson Blvd., Chicago, Ill.

Please send following books (.....c enclosed)

- FREE**  37-750  37-752  37-754  
 **Buying**  37-751  37-753  37-755  
 **Guide**  No. 37-799 (All Six Books)

Name.....

Address.....

City..... State.....

**ALLIED RADIO**

# A New 90-Foot Mast

A NEW 90-foot tubular steel radio mast is this "Speed King," recently announced by the Harco Steel Construction Co. The makers believe that it is the quickest of erection of all masts of similar type.

The 90 foot unit, with a cross-arm 8 feet long, when dismantled occupies less than 12 cubic feet of shipping space and weighs only 750 pounds. The entire unit can be erected by five men in approximately one hour, including every operation from the setting of the ground anchors to the attachment of the auxiliary cross arm at the top.

Capable of withstanding a wind velocity of 125 miles per hour without ice or 100 miles per hour with 3/4-inch ice, this Radio Mast has found wide and successful war-time use in the communications field, and offers a broad field of post-war applications, both in temporary and permanent installations.

Built of light-weight steel tubing, a relatively high strength-weight ratio is obtained. Each of the sections slides over or under the adjoining member for a length of 24 inches and both members are rigidly joined through an ingenious use of tapered bars and wedges.

The connections so made are described as being even stronger than the members themselves. The tapered bars serve to

bring the connecting sections automatically into position. The wedges are easily inserted and have a small hole at the bottom to serve as anchor for the guy cables. In dismantling the tower, the wedges can be

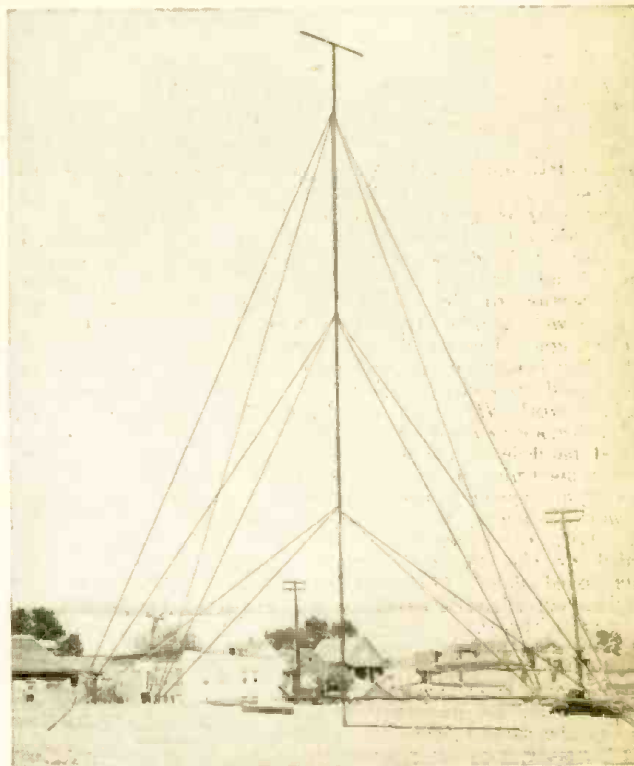

quickly removed as each section comes down.

The smallest section of the 90-foot unit is 3 1/4-inches in diameter and the sections increase to 4 1/2-inches in the center, thus keeping the visibility to a minimum.

These units have been built in various sizes and are available in heights from 25 feet to 200 feet.

## RADIO IS VALUABLE WEAPON IN HOLLAND

**HOLLANDERS** under the Nazi heel find the United Nations radio their most valuable hidden weapon, according to the Netherlands Information Bureau.

Heavy fines have been inflicted and jail sentences given to more than 100 Netherlands found with radio apparatus capable of picking up foreign stations. The terrible Dutch stubbornness has been too well known to the Germans for many centuries to encourage them to set death penalties for "illegal listening," as in the Reich itself. The Nazis complain bitterly that the number listening illegally is "several times larger than those listening legitimately."

Hollanders are using every conceivable place for their receivers, putting them under floors, inside upholstered furniture and stoves, in empty garden ponds, in chimneys and even in laundry baskets or under the potatoes in the bin.

Radio broadcasts from United Nations sources recognize the difficulties under which the Dutch public are compelled to

listen. No loud music or signature melodies are broadcast, and news is read at a rate which permits transcription.

Those few Hollanders who were timid enough to turn in their receivers were given a Dutch rebuke last summer when patriots burned the warehouses in which their radios had been kept. The Nazis reported that most of the sets handed over were so old as to be unusable, anyway.

"Radios," according to the Nazis, "are a strong and dangerous weapon in the hands of the Dutch." And there is ample proof of that statement. The news of the landing in Tunisia last year spread all through Holland within a few days. Dutch Premier Gerbrandy's recent broadcast from London urging civil servants in the Netherlands to protect their countrymen against deportation, hunger, forced labor, etc., was followed shortly by similar instructions through the underground press. Thanks to the radio, the Dutch will be ready to strike against the Nazis when the war returns to Holland,

## AUDIO DISTORTION

(Continued from page 409)

termodulation effects are not only highly complex but also cause harsh dissonance effects which still further accentuate those of intermodulation distortion.

If three such odd-order frequencies are sent through an ordinary amplifier simultaneously, it may be found that the total audio distortion developed at maximum amplifier output might actually total three to four hundred per cent over that indicated by a simple single-frequency sine-wave signal check of the amplifier's frequency response.

Two similar amplifiers may thus be rated at the same percentage harmonic distortion at the same watts output, yet one may sound definitely better to a listener's ear. This may be perfectly true since one amplifier may be generating more of the higher odd-order harmonics and therefore more of the damaging dissonance intermodulation distortion at the "knee" or "bend" section of the amplifier response curve, as well as other types of distortion too often ignored in sound work today.

This fact brings out an interesting point with regard to audio distortion in radio broadcast work. With the above factors in mind, it becomes evident that many orchestra and band leaders and arrangers miscalculate somewhat in their choice of compositions, arrangements and harmony in radio work. Modern, unorthodox, "dissonance" type of compositions should be avoided or else the orchestral arrangements toned down. Otherwise the complex dissonance harmony will emerge from the receiver speaker with a highly "sour" quality because of excessive odd-order intermodulation distortion effects. Dance orchestras might tone down their odd-order harmonic overtone-generating brass sections for the same reason.

Furthermore, some orchestra leaders resort to a trick known as "off-keying" where certain instruments are deliberately thrown off pitch in order to obtain a peculiar and rather pleasant beat-frequency effect to the over-all orchestral tone-effect. While this effect may be pleasant enough to an audience actually listening to the orchestra, the effect is anything but musical after the complex dissonance frequencies pass through the maze of broadcast transmitter and receiver circuits with all their attendant distortion effects.

Thus audio amplifier design men must not be misled by harmonic distortion ratings of amplifier tubes and audio components. If only harmonic distortion ratings are available, then the types and their individual percentages should be checked in order to estimate the possible total intermodulation distortion that might be generated in the audio system.

If one amplifier tube generates more odd-order harmonics than another and both generate the same amount of total harmonics, the one generating the greater amount of odd-order harmonics will generate more total audio distortion than the one generating the greater amount of even-order harmonics. If two amplifier tubes generate equal amounts of odd-order harmonics, the tube generating the greater amount of higher-order harmonics will generate more total distortion since it will generate more intermodulation distortion at the "bend" at the upper end of the amplifier's frequency response curve, where it is most damaging to fidelity.

These facts explain the peculiar "tinny" and harsh audio quality sometimes charac-

teristic of amplifiers using hi-mu triodes and pentodes. Low-mu triodes generate practically no odd-order harmonics and will deliver much higher fidelity output, even though this should not be the case according to comparative harmonic distortion ratings of both the triode in question and higher mu triode and pentode amplifier tubes. The simple harmonics ratings do not take intermodulation effects into account.

Obviously then, the harmonic distortion method of rating audio equipment will eventually have to be discarded and some sort of triple-odd-order frequency intermodulation distortion rating may have to be adopted. Some sort of a complex frequency signal similar to a 33-301-211 cycle signal might be suitable. Such an outlandish ear-jarring chord will show up an amplifier's true performance capabilities under actual complex frequency operating conditions.

Intermodulation distortion can be checked by elaborate complex-frequency generator and frequency analyzer equipment or by the more rapid square-wave generator and cathode-ray oscilloscope technique.

Since a multivibrator's square-wave signal consists of a complex array of component frequencies which may be represented by the expression

$$e = \frac{\pi}{4} \cos t + \frac{1}{3} \cos 3t + \frac{1}{5} \cos 5t$$

an ideal complex signal is available for checking intermodulation distortion, especially if an odd-order fundamental is chosen.

An amplifier considered to be "distortionless" over the useful audio range and supposedly generating about two per cent harmonics, may show a considerable peak or peaks on the flat top of the square wave which will indicate much more total harmonic, intermodulation and other types of audio distortion. The height of the peak or peaks will roughly indicate the amount of distortion, and the width and position of these peaks show the frequency ranges at which the distortion is taking place. Various deformations of the square-wave signals will indicate the different distortion effects existing in the amplifier.

Communication on all the islands in the South Pacific area is by wire, states Col. Francis L. Ankenbrandt, Signal Officer of the U. S. Army forces in the South Pacific theater. Inter-island communication is by radio. Both systems are entirely dependable, says Col. Ankenbrandt.

# ELECTRICITY

## For Any Job Anywhere

For a dependable source of electricity on projects remote from commercial power, Onan Electric Plants are proven leaders in the field. More than half of the Armed Forces' total requirements for Power Plants are built by Onan.

Gasoline driven—single-unit . . . Compact design . . . sturdy construction . . . Suitable for mobile, stationary or emergency applications.

Over 65 models, ranging in sizes from 350 to 35,000 watts. 50 to 800 cycles, 110 to 660 volts, A.C. . . . 6 to 4000 volts, D.C. . . . also dual A.C.-D.C. output types.

Descriptive literature sent promptly on request. D. W. ONAN & SONS, 732 Royalston Ave., Minneapolis, Minn.

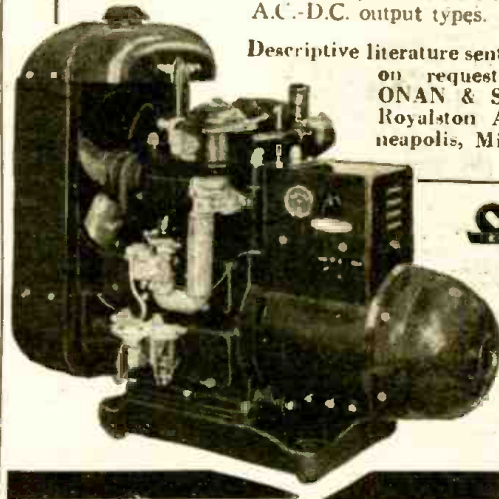

**ONAN**  
ELECTRIC PLANTS



Awarded to each of the four manufacturing Plants of D. W. Onan & Sons.



### 4 STANDARD TYPES

of Amperite Regulators replace over 400 types of AC-DC Ballast Tubes now in use.

Amperites are real REGULATORS . . . have patented Automatic Starting Resistor which prevents initial surge and saves pilot lights . . . Ask Your Jobber.

# AMPERITE

THE *Simplest*  
WAY TO REPLACE

# BALLASTS

WRITE FOR REPLACEMENT CHART

AMPERITE Co. 561 BROADWAY, NEW YORK, N. Y.

# FOR SALE

## HARD-TO-GET ITEMS

All items are brand new, except where indicated. ALL are in PERFECT WORKING ORDER. In many cases, the parts alone total more than the price we are asking. Satisfaction guaranteed or your money back. ORDER FROM THIS PAGE. Use our convenient coupon. Include sufficient extra remittance for parcel post charges, otherwise order is sent express collect. Any excess will be refunded. All C.O.D. shipments require 20% deposit. No C.O.D. shipments on orders for less than \$3.00. If full remittance accompanies order, deduct 2% discount. Send money order, certified check, or new U. S. stamps. No C. O. D.'s to foreign countries.

**ULTRA MAGNET**  
LIFTS MORE THAN 20 TIMES ITS OWN WEIGHT  
**LITTLE GIANT MAGNET**  
Lifts 5 lbs. easily. Weighs 4 oz. Blade of ALNICO new high-magnetic steel. Complete with keeper. World's most powerful magnet. The experimenter and hobbyist will find hundreds of excellent uses for this high quality permanent magnet. Measures 1 3/4" x 1 1/4". Ship. Wt. 3 1/2 lbs.  
ITEM NO. 159  
YOUR PRICE **\$1.25**



### GENUINE MICROPHONE TRANSMITTERS

These are regular "telephone transmitters" of the type used on wall telephones. Taken from a large telephone supply company's overstock, these fine mikes offer a grand opportunity to obtain a splendid unit for little more than the price usually asked for a simple "microphone button". The amateur experimenter and telephone mechanic will find a variety of uses for these excellent microphones. They work perfectly on 2 dry cells. Can be used on P.A. systems for voice transmissions, in call systems and intercommunications sets. With telephone receivers (radio headphones) they will do their best in home-to-house or farm-to-farm phone lines. You can use them to talk through your own radio, or as concealed dictaphone pickup units for listening to conversations in a distant room or building. The telephone mechanic will find them useful replacements on battery-operated telephones.

**THESE ARE NEW, GENUINE TRANSMITTERS, MADE BY KELLOGG, WESTERN ELECTRIC AND STROMBERG-CARLSON.** Excellent in appearance and operation. A remarkable value, and one seldom offered in these times. Ship. Wt. 1 lb.  
ITEM NO. 160  
YOUR PRICE **\$1.50**



### AMAZING BLACK LIGHT!!

Powerful 250-Watt Ultra-Violet Source

The best and most practical source of ultra-violet light for experimental and entertainment use. Makes all fluorescent substances brilliantly luminescent. No transformer of any kind needed. Fits any standard lamp socket. Made with special filter glass permitting only ultra-violet rays to come through. Brings out beautiful opalescent hues in various kinds of materials. Swell for amateur parties, plays, etc. To obtain unique lightning effect. Bulb only. (Ship. Wt. 1 lb.)  
ITEM NO. 87  
YOUR PRICE **\$2.45**



### WATT HOUR METER

Completely overhauled and ready for immediate service. Designed for regular 110-volt, 60 cycle 2-wire A.C. circuit. Servicemen use it in their shops to check current consumption of sets, soldering irons, etc. Keeps costs down. If dismantled, the parts alone would bring the price. The elaborate gear train could be used as a counter on machines of various kinds. Simple to install: 2 wires from the line and 2 wires to the load. Sturdily constructed in heavy metal case. 8 1/2" high. 5 1/2" deep. Westinghouse, G. E., Ft. Wayne or other available make. Ship. Wt. 4 lbs.  
ITEM NO. 33  
YOUR PRICE **\$4.95**



### LIMITED QUANTITIES! PROMPT SHIPMENTS!

It's Easy to order—Clip Coupon—Order from This Page—No Catalog Sent. MAIL TODAY—NOW!  
(See Corresponding Ad. Page 436)

**HUDSON SPECIALTIES CO.**  
40 West Broadway, Dept. RC-4-44, New York 7, N. Y.  
I have elected below the numbers of the items I'm ordering. My full remittance of \$... (No C.O.D. orders unless accompanied with a deposit.) OR my deposit of \$... is enclosed (20% required, ship order, C.O.D. balance. NO C.O.D. ORDER FOR LESS THAN \$3.00. (New U. S. stamps, check or money order accepted.)  
Circle Item No. wanted: 33 87 159 160

Name \_\_\_\_\_  
Address \_\_\_\_\_  
City \_\_\_\_\_ State \_\_\_\_\_  
Send remittance by check, stamps or money order; register letter if you send cash or stamps.

## INDUSTRIAL ELECTRONICS

(Continued from page 403)

.0000002 of an inch are the gauges used to set and adjust the routine instruments for linear measurement throughout the plant. Cam-shaft bearings and push-rods must now be within .0005 of size. So close are some of the limits of tolerance that the ordinary fluctuation of temperature, with resulting expansion and contraction, is a most distressing factor. Speed with accuracy is no small problem. A gauge set to .0001 inch is an annoyingly capricious affair. A few contacts with the objects to be measured induce inaccuracy through the slight abrasion incident to application. If we held a wristpin in our hand for over twenty-five seconds, the body heat communicated to it in this short time would be sufficient to cause expansion of .0001 inch. Hence the fight on thermal expansion has been as uncompromising as it has been ingenious.

One of the problems involved in the application of photocells had to do with the extraction of the heat from the light beam used. The trick of measuring is a simple one. The part to be measured merely casts its shadow. Excess light is gauged by the photocell and a red light flashes the signal of rejection. In the case of wristpins, those measuring .85909 or under are scrapped. Passage is limited between .8592 and .85929.

The smart Chrysler Company has pioneered in this sort of robotized measurement. If extraneous factors such as vibration and thermal expansion did not enter, tolerance could be placed at .0000001 inch plus or minus. The machinist's calipers are crude yardsticks by comparison. Electronic rulers are now applied to wire mills, where they stand ready to stop a machine automatically, as soon as the drawing die falls outside the pale of tolerance.

### ELECTRONICS IN THE GARAGE

A slow but persistent invasion of the commercial garage is now in evidence. Here the cathode-ray tube, now cheap and reliable, instantly checks distributor heads, batteries, lights and contacting devices. It ac-

complishes within fifteen minutes what an automotive electrician could not do within two hours. Photo-electric analyzers are butted up to headlights to check glare and intensity. The robot marches on.

### TUBES AND TEXTILES

The textile industry, long hampered by the human element, long buried under acres of slow-moving, costly looms, promises to receive its electronic shot-in-the-arm within the next few years. The manufacturers of print fabrics have long been annoyed with skew. When the cloth passes through the finishing operation it is vitally necessary that the selvage edges are adjusted so the weft threads are square with the warp threads. Otherwise, the design printed on the material will be noticeably distorted. Heretofore, a human operator with manual controls has sweated to keep the cloth in a condition to receive such impressions. With cloth speeding by at 40 yards per minute, consistent alertness of a type which is rarely available, is of utmost necessity. By the application of a most ingenious trick, a photocell has been able to jump into the operator's shoes.

The set-up is simple, consisting of two photo-cells, mounted at opposite ends of the roll over which the cloth passes.

The threads in the woven cloth passing by the photocells, one placed on either side of the machine, vary between 280 and 8,400 per second depending upon the type of material being printed. These threads interrupt the light reaching the cells and produce a definitely rhythmic current which under ideal conditions should be synchronous; that is, the current in one cell should have a wave-form exactly the same as that in the other. Should this perfect balance fail, a circuit made especially responsive to frequency changes is thrown into operation and a retarding or advancing movement is applied to one side or the other. Neat but not especially gaudy, says the electronic engineer somewhat dryly.

### RADIUM-RADIO RECEIVER

(Continued from page 399)

news. That is exactly what I have accomplished in my present Radium-Radio Receiver. This is how it works:

At the broadcast station we have a special metallic gong arranged in such a manner that it will give a certain musical note. When this gong is struck with great force, a more than normal power-note is broadcast. In my set I have a tuned reed. This reed is tuned only to this special broadcast gong. Remember that the set is never turned off. When this special note comes over the circuit in my set, the reed starts vibrating, thereby making a contact which turns the set on to its "high" volume point. Immediately the news, such as important war news, catastrophes, etc., is received with full power on my new radio set, and with such strength that the entire household cannot fail to hear it. The volume is strong enough to wake up a hearty sleeper. After the news has been received, the owner of the radio set turns it down again to the "low" point, and the receiver is then ready for the next impulse when it comes along.

wide four more extra reeds. Number 1 is marked 5 A.M.; Number 2, 6 A.M.; Number 3, 7 A.M.; Number 4, 8 A.M. Before you retire, you turn a little knob which puts one of the reeds into the circuit. Each reed is tuned to a different note. Every broadcast station (besides the large "news gong") will have four other gongs or whistles, all tuned to the four reeds of your set. Suppose you wish to get up at 8 A.M. and have turned the little knob on its appropriate reed marked 8 A.M. In due time in the morning, the 5, 6 and 7 o'clock gongs or whistles will sound in the broadcast station (to which your set is tuned), but nothing happens because none of the three reeds will be in the circuit, but at 8 o'clock the last reed will be connected and, consequently, it will begin to vibrate, thus making its appropriate contact. This automatically turns on the set to "high" and the radio goes on full blast, awakening you on the dot.

### THE AD-PLUG-ELIMINATOR

That, however, is not all. I incorporated still another device in my set which I term "ad-plug-eliminator."

Many people have been exasperated by a number of the smaller radio stations

### THE RADIO ALARM

This impulse—but a different kind—comes early in the morning when you desire to be awakened. Besides the special reed for news and other purposes, I pro-

which plug continuously trashy ads over the air. This has been a "thorn in the ear" of many listeners. While lucrative for the broadcast interests, it is often very annoying to the radio set owner. For those who do not wish to listen to repeated low class advertising plugs, there is a button on my set marked "ad-plug-eliminator" which can be turned. Its *modus operandi* is as follows:

I used the now well-known memory device of which several are made at the present time.\* This is nothing but an electrical robot which has a "memory." I have improved upon the present device in such a manner that once the radio set "hears" one of the many ad plugs, it stores it permanently in its mechanical brain. Then as soon as the same advertising plug begins again, the robot cuts the set off the air until the plug is finished, then the set is turned "on" again. In practice this works very well, but it is not to be confused with dignified occasional advertising of important programs. Only those 30 seconds or one minute PURE ad-plugs which are a bane to so many people nowadays, are affected.

The photographs in these pages show not only the new Radium-Radio Tube but the new Radium-Radio receiver as well.

Now you would naturally assume that a great and revolutionary invention of this type should get immediate acceptance by the large radio manufacturers, but alas, the contrary is the fact.

#### A PERSECUTED INVENTOR

When I had my final model built, I immediately made it my business to go and see one of our great radio set manufacturing companies. They seemed much interested but insisted on buying the invention outright. Having had such experiences with other inventions of my own, I told them I was not interested in any outright sale but preferred a royalty arrangement; I indicated that I would be satisfied with a modest royalty for each tube and set. After several months of haggling, nothing came of all this, until one day I was called into the office of the president of the corporation who proceeded to give me a long lecture. I do not wish to tire the reader by telling him all that transpired there, but the following was made plain:

The president called my attention to the fact that a revolutionary invention such as mine would immediately raise havoc with the following powerful interests:

- (1) the radio tube interests;
- (2) the radio set-building industry;
- (3) the electric light and power industry;
- (4) the alarm clock industry;
- (5) the battery industry;
- (6) a goodly number of others.

The president pointed out to me that, for instance, the radio tube interests would immediately have their tube business cut tremendously because my set only uses a single tube. Worst of all, with a tube lasting theoretically 2500 years, there would be no tube replacements and once a tube was sold that would be the end of it, consequently the radio tube business would be "shot to Hell in no time"—these were the president's exact words.

Then there was the radio set-building industry. Instead of getting prices anywhere from \$50.00 to several hundred dollars for a set, "they will starve to death by making your cheap and popular, *pauper's set*." I am using the president's words verbatim again.

Then there would be the electric power interests. These gentlemen, too, would be hurt tremendously, because today radio sets use a most substantial amount of power;

\*See Radio-Craft, July, 1943, page 588, "Electric Memory Machine Helps Ignition Study."

this is very lucrative business which the electric power industry would miss severely.

Next in line was the venerable old alarm clock industry, which by means of my "crazy fool" set would be totally deprived of ALL of their business. Three-quarters of them would surely go out of business entirely because my radio receiver, being in a way an alarm clock itself, would be too powerful a competitor for the alarm clock business, thought the president.

That leaves the broadcast interests, who, as I have already hinted above, would now be deprived of one of their most lucrative business plums—that is, short ad plugs now so common in America. Inasmuch as most of the small radio stations have to depend upon this type of business and as "that is their bread and butter, your hair-brained crazy 'mouse-trap radio' would put 60% of these poor stations out of business immediately." I am once more quoting the president.

Then there is the battery industry which would be deprived of their "B" battery and "A" battery (portable sets) business as well, according to my spokesman. He cited several other industries which I was about to kill, and he left me dazed when he handed me a tabulation of all the millions of dollars' worth of business which my invention would exterminate with one "fell swoop"—in the president's words.

#### Losses to Affected Industries Due to Radium-Radio Set

(1) Radio Tube Companies	\$128,000,000.06
(2) Radio Set-Building Industry	226,000,000.58
(3) Electric Light and Power Industry	74,950,000.89
(4) Alarm Clock Industry	46,890,000.65
(5) Battery Industry	24,650,000.28
(6) Other Industries	74,000,000.95

**TOTAL LOSS** \$574,490,003.41

I told him that I could see some justification in his contention but I also said that progress was like that and that the same argument could have been given to the inventor of the automobile, which put the horse and carriage trade out of business, too. I quoted many other new inventions which worked havoc in a parallel line. "But," I continued, "you also must remember that when one of these revolutionary inventions comes along, it also benefits the public at large, and, damn it, I'm for the public—first, last and always."

(Continued on following page)



**HIGH EFFICIENCY**  
results in  
**Sound National**  
**Defense**  
that is why  
**NATIONAL DE-**  
**FENSE SOUND**  
**SYSTEMS**  
are equipped with  
**University Reflex**  
**HIGH POWER**  
**LOUDSPEAKERS**  
**UNIVERSITY LABS.**  
225 VARICK ST. N. Y. C.

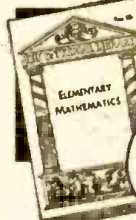

**The Book that Takes**  
**Drudgery out of**  
**Mathematics**

Only **50c**  
postpaid

Entire Chapter on  
Special Mathematics  
for the Radio Techni-  
cian.

## ELEMENTARY MATHEMATICS

● EASY — SIMPLIFIED — PRACTICAL ●

Here is the book that gives you a good background in mathematics, that takes all the irritation and drudgery out of it. You don't need to be scared of mathematics, because here's the subject explained without frills, without useless computations.

#### CONTENTS OF BOOK

- CHAPTER I. Arithmetic—Addition—Subtraction—Multiplication—Division.
- CHAPTER II. Factoring and Cancellation—Fractions—Decimals—Percentage—Ratio and Proportion.
- CHAPTER III. The Metric System.
- CHAPTER IV. How to Measure Surfaces and Capacity (Geometry).
- CHAPTER V. Powers and Involution—Roots and Evolution.
- CHAPTER VI. Mathematics for the Manual and Technical Craftsmen—Thermometer conversions—Graphs or Curve Plotting—Logarithms—Use of the Slide Rule.
- CHAPTER VII. Special Mathematics for the Radio Technician.
- CHAPTER VIII. Commercial Calculations—Interest—Discounts—Short Cut Arithmetic.
- CHAPTER IX. Weights and Measures—Useful Tables.

ONLY  
**50c**  
POSTPAID

Send today for your copy of this indispensable book. It can be carried readily in your pocket. (See p. 9.)

Send Stamps, Cash or Money Order to

## TECHNIFAX

1917 S. STATE ST., RC-4-44, Chicago, Ill.

**TECHNIFAX** 1917 S. State St., Chicago, Ill.

Enclosed herewith 50 cents, for which mail to address below your **ELEMENTARY MATHEMATICS**.

NAME .....

ADDRESS .....

CITY ..... STATE .....

RC-4-44

# Something New in AB BATTERIES

## Assemble It Yourself!

Delivers: B Pos. & Neg. 90 Volts  
A Pos. & Neg. 1 1/2 Volt



Pictured is our new type Radio AB Battery, that can be made up by any radio service man at a nice profit.

This new improved rechargeable battery replaces the dry type battery with the advantage that it lasts four or five years. The cost of radio operation with this battery is reduced to as little as twenty-five cents a month.

This unit operates up to three hundred hours on each charge. We have now assembled over five hundred of these units which are in the field giving good service.

We cannot supply the assembled unit but will supply any service man with complete kit of vibrator and all parts to go on battery, with complete instructions. Price \$9.50.

**BROWN'S RADIO CENTER**  
224 No. Court St., Florence, Ala.

# FOR SALE HARD-TO-GET ITEMS

All items are brand new, except where indicated. All are in PERFECT WORKING ORDER in many cases, the parts alone total more than the price we are asking. Satisfaction guaranteed or your money back. ORDER FROM THIS PAGE. Use our convenient coupon. Include sufficient extra remittance for parcel post charges, otherwise order is sent express collect. Any excess will be refunded. All C.O.D. shipments require 20% deposit. No C.O.D. shipments on orders for less than \$3.00. If full remittance accompanies order, deduct 2% discount. Send money order, certified check, or new U. S. stamps, No C. O. D.'s to foreign countries.

## THE MAGIC ELECTRIC WELDER



Here is one of the most compact, practical welders we have ever seen. Anyone can use it for shop, farm and home repairs. **U. S. SIZES. SOLDERS. CUTS ALL METALS. ANYONE CAN OPERATE IT.** Repairs steel, cast iron, aluminum, brass, copper, bronze, etc. Complete with power unit, flame and metallic arc attachments. Carbons, fluxes, rods, mask included. Just plug it in any electric outlet. 110 volts AC or DC. For hobbyist or professional.

**GET IN ON THE GREAT WELDING BOOM.** This fine set quickly teaches you welding. Low cost to operate—about 5¢ an hour. COMPLETE SAFETY. Is assured. No fumes with this outfit. SET COMES COMPLETE—nothing else to buy. Used by the U. S. Navy, American Tel. & Teleg. Co.; Eastman Kodak Co.; Bell Laboratories, etc. BRAND NEW OUTLET. Guaranteed for one year. Complete simple instructions with each set.

**\$19.95**

ITEM NO. 150

YOUR PRICE .....

## WESTERN ELECTRIC BREAST MIKE

This is a fine light-weight aircraft carbon microphone. It weighs only 1 lb.

Mike comes with breastplate mounting and has 2-way swiveling adjustment so that it can be adjusted to any desired position. There are 2 woven straps; one goes around neck, the other around chest. Straps can be snapped on and off quickly by an ingenious arrangement.

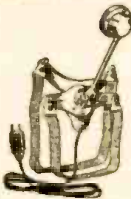

This excellent mike can be adapted for home broadcasting or private communication systems. By dismantling breastplate, it can be used as desk mike.

Comes complete with 6-foot cord and hard rubber DNR. Finished in sherardized plate, non-rustable.

**THIS IS A BRAND NEW MIKE. IT HAS NEVER BEEN SOLD AT SUCH A LOW PRICE BEFORE. ORIGINAL LIST PRICE \$15.00. Shipping weight, 2 lbs.**

**\$2.55**

ITEM NO. 152

YOUR PRICE .....

## POWERFUL ALL-PURPOSE INDUCTION MOTOR

IDEAL FOR EXPERIMENTERS—101 USES

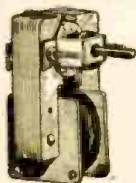

Sturdily constructed to precision standards, this self-starting shaded pole A.C. induction motor is powerful enough for a number of uses. Some of these are: Automatic Timing Devices, Current Interrupters, Electric Fans, Electric Chimes, Window Displays, Photocell Control Devices, Electric Vibrators, Small Grinders, Buffers and Polishers, Miniature Pumps, Mechanical Models, Sirens, and other applications.

Consumes about 15 watts of power and has a speed of 3,000 R.P.M. When geared down, this sturdy unit will constantly operate at an 18-inch turntable loaded

with 200 lbs. dead weight—**THAT'S POWER!** Dimensions 3" high by 2" wide by 1 3/4" deep; has 4 convenient mounting studs; shaft is 3/8" long by 3/16" diameter, and runs in self-aligning oil-retaining bearings. Designed for 110-220 volts, 50-60 cycles, A.C. only.

**\$1.95**

ITEM NO. 347

YOUR PRICE .....

## LIMITED QUANTITIES! PROMPT SHIPMENTS!

It's Easy to order—Clip Coupon—Order from This Page—No Catalog Sent.

(See Corresponding Ad Page 434)

MAIL TODAY—NOW!

### HUDSON SPECIALTIES CO.

40 West Broadway, Dept. RC-4-44, New York 7, N. Y.

I have circled below the number of the items I'm ordering. My full remittance of \$..... (include shipping charges) is enclosed. (NO C.O.D. ORDERS UNLESS ACCOMPANIED WITH A DEPOSIT.)

OR my deposit of \$..... is enclosed (20% required), ship order C.O.D. for balance. NO C.O.D. ORDER FOR LESS THAN \$3.00. (New U. S. stamps, check or money order accepted.)

Circle Item No. wanted 147 152 158

Name .....

Address .....

Please Print Clearly

City .....

State .....

Send remittance by check, stamps or money order; register letter if you send cash or stamps.

(Continued from previous page)

Then I gave him my ultimatum and told him that if he and his interests did not wish to buy my great invention at my own terms, I would start in the manufacturing business with private capital and manufacture the tubes and sets myself. He got very angry at this and we parted enemies.

That was the beginning of my troubles. One night when I was putting the finishing touches to my radio set in my laboratory, there came a knock on the door.

Being unmarried, I had only one good and trusty friend, and that was Annie. Annie is my pet ant-eater. She was very useful around the laboratory because at one time I was interested in ants and built those little ant houses—the contrivances with live ants which you study through a plate glass. Sometimes some of the ants would escape, then Annie would eagerly lap them up so that they would not run all over the house and laboratory. Annie, too, liked to eat sawdust and small shavings, and when I was busy filing a piece of metal she didn't mind eating some of the filings, as "roughage."

Well, as I said before, there was an ominous knock at the door. Innocently enough I opened it, only to have a couple of burly gangsters jump me and I was tied hand and foot in no time. Poor Annie, too, was kidnapped along with me. They put her in a canvas bag, however, and lugged her along. There followed an interminable automobile ride and I sure thought my end had come. At dawn we pulled up in a wild-looking place which afterwards proved to be a small island in the midst of a lake.

For two years I was confined in a sort of prison with a heavy iron grating, making

my escape impossible. I was treated well enough during this period and we had enough food. When I say "we," I mean Annie and I. If it had not been for Annie, I think I would have died of loneliness. Several months ago during a terrific storm with an accompanying fire, I found a chance to escape—how I shall not say here for a number of reasons. I immediately decided that my life was no longer worth a plugged nickel, because I knew that the big interests were after me and would use every possible means to stop me from marketing my invention.

So I decided that I would publish my entire invention in the pages of my favorite magazine, RADIO-CRAFT, because I knew they would be courageous enough to at least give the world the news of my epoch-making inventions.

Unfortunately, there were several reasons why I could not prosecute the big interests which kidnapped me and kept me out of circulation for two years. The main reason is that I have no absolute proofs against them. Then, Annie was still in "jail" and I was in mortal fear that if I mentioned any names the gang would probably kill the poor companion of my kidnapping days.

Since I returned home, I have written the president of the great radio corporation and told him that unless Annie was returned on a specified date, I would expose him and his bloodthirsty gang.

The puzzling part of the entire proceedings is that the day I finished this story, I received a mysterious telegram from the president. Curiously enough, it contained only this:

APRIL FOOL.

## A SHORT COURSE IN PRACTICAL ELECTRONICS (Cont. from page 406)

Metals such as zinc and aluminum, which have more than one electron in the outer shell, may also be good conductors.

Substances which have complete outer shells might be expected to be good insulators. Quartz is one of the best insulators known. It is a combination of two atoms of oxygen with one of silicon. Silicon has four electrons in an outer shell with room for eight—oxygen lacks two to complete its outer shell. The four outside electrons of the silicon atom fill in the spaces in the two atoms of oxygen in such a way as to produce a singularly contented molecule—one into or out of which it is next to impossible to drive an electron. Many sub-

stances, such as glass, certain plastics, rubber and many oils and waxes, are so constituted that they are extremely useful wherever it is desired that there shall be no electron flow.

So we see that we have plenty of raw material for Electronics. Electrons are by far the commonest things in existence. Already we have seen that there is nothing mysterious about the electron—that it is far simpler than a grain of sand, for electrons are only one of the things that compose a grain of sand. If we deal with the electron in this spirit, it will be found relatively easy to understand all types of devices which depend on it for their operation.

## THE NAZIS ARE FIRST

(Continued from page 393)

glider bomb described in these pages is another German application of something ancient, but sniffed at by our own War Department. While it may be true that the device is not a world beater, it is being used right along against Allied shipping and is still harassing us at this very moment. There is no question but that many other radio-controlled devices will be used against us and our men at sea, on land and in the air by the Nazis before we will have effected counter devices. In the meanwhile, we prefer not to take these devices seriously, but the Germans go merrily along, using obvious weapons against us which we should have first, and springing them on us instead.

Late in February Prime Minister Winston Churchill once more told the same story to the House of Commons. This time it is a Nazi radio-controlled rocket bomb. The "new" weapon is either a crewless air-

craft or a winged bomb. It is launched into the air from an inclined runway, according to British reports. An automatic, probably gyroscopic, pilot keeps the machine flying at a straight level and its course is controlled and checked by radio. By this means the winged bomb is directed at targets such as cities. Such targets are very large, and for this reason allow a good margin of error in aiming.

The same dispatch further mentions the fact that the German Aircraft Radio Research Station at Peenemünde on the Baltic has been making extensive experiments with remote radio-controlled aircraft, as well as with jet propulsion and the magnetic direction of torpedoes and other weapons. The radio glider bomb which made its first appearance in the Mediterranean war theatre, late in 1943, was engineered at Peenemünde.

As we go to press, an Algiers dispatch

dated March 1, tells of still another "Nazi First"—"a radio remote-controlled tank, carrying 1,000 lbs. of high explosive to its target, where it can be exploded at will."

Fourteen of these manless radio tanks had been knocked out by Allied artillery before they reached the Allied lines in the big battle which ended Feb. 19, on the beach-head below Rome. The dispatch does not state how many Allied casualties other similar German radio tanks caused, nor what material damage they did to the Allies.

None of these devices is really new or startling. They have been known to our own and other Allied Government War Departments for many years. Thus, for instance, the idea of the radio-controlled airplane is over 25 years old.

But the point I wish to make in all of this is, that the Nazis use these ancient ideas against us, while we sit by and wait for them to beat us to the punch. We talk—the Germans act.

There is no country better equipped to manufacture radio-controlled devices on a large scale than America, and I think it is about time that our own War Department should bestir itself and beat the enemy to it for a change. The war is not won by a long shot, and we will not win it by shrugging our shoulders and maintaining that the Germans are crazy with their foolish war devices.

Particularly against the Japanese, radio-controlled devices will be even more important for us than against the Germans.

There remains the sore point of ridiculous American censorship on some of these war devices. There is very little that is new, particularly in radio, at this time. The childish attitude of war censorship on radio devices at the present time is only of help to the enemy. This country possesses excellent technicians and outstanding inventors, but many of these who are not working on war jobs right now, are prevented from making their contributions simply on account of this censorship. Take, for instance, Radar. The Germans and the Japanese have been using it just as long as we have, even at the height of the battle of England, when Radar was supposedly the one agency that saved Britain—the Nazis were using it in France. This necessitated a number of English commando raids against the French coast in order to destroy German Radar installations. Yet, with the Allies and the enemy, both using the device, it is still the great hush-hush invention with us—which must make the enemy laugh. Indeed, at the present time one wonders if the Germans do not use a better Radar system than even the Allies have. It is well known that the Nazis have equipped practically all of their anti-aircraft guns with their own Radar device, and judging from their success in bringing down Allied planes, their device must be first rate. So why all the Radar secrecy today?

Perhaps outside inventors could make helpful suggestions on how to improve our own devices, but in this they are prevented on account of the censorship, which forbids anything to be published on the sacrosanct Radar, although it dates to 1932.

In the meanwhile, our own War Department could do much to rectify the situation by having a little more faith in the American inventor and our own technicians, and for once beat the enemy to the punch, not necessarily with more planes, more ships and more artillery, but particularly with NEW radio-controlled devices—WHICH WILL SAVE THOUSANDS OF OUR MEN'S LIVES—before the enemy makes further fools of us.

\*See the writer's article, "Radio Pilot Mine Destroyers," Dec., 1943. RADIO-CRAFT.

A view of the British Navy's underground wireless station at Famagusta, Cyprus. Here, deep below the earth and relatively secure from both aerial bombs and shells, Signallers of the Royal Navy maintain reliable communication with military units of the United Nations in the area.



# RADIO-CRAFT'S LIBRARY

presents

## 4 BEST SELLERS

NO 25

RADIO CRAFT LIBRARY N° 25

**HOME-MADE RADIO TEST INSTRUMENTS**

NO 26

RADIO CRAFT LIBRARY N° 26

**MODERN BATTERY RADIO SETS**

NO 27

RADIO CRAFT LIBRARY N° 27

**MODERN RADIO SERVICING TECHNIQUE**

NO 28

RADIO CRAFT LIBRARY N° 28

**ALL ABOUT FREQUENCY MODULATION**

**ONLY 50¢ EACH**  
3 BOOKS \$1.25  
4 BOOKS \$1.50

**HERE** are four of the handiest, most informative books that this popular technical library ever turned out. They hardly need an introduction. Their usefulness is already an established fact, proven on the best "proving ground" in the world: "The field of practical application."

Yes, indeed, thousands upon thousands of technicians, servicemen, experimenters, trainees use these books daily. They are just the right size to slip in the pocket so you can read them when travelling. The knowledge gained from these self-help books can be used in countless ways; for example, in building a home-set, when servicing an outside job; or when preparing for an examination. Many men in the armed services who are aiming toward a higher rating are making excellent use of these books. The price, only 50¢ each, and less when you buy more than one at a time, is trifling when you consider that the first application of the knowledge gained will likely pay the cost of all four books.

**No. 25—Home-Made Radio Test Instruments**  
Outline of Contents: A Low-Cost Signal Chaser—Signal Tracer Test Unit—Simplified Practical Signal Tracer—A Home-Made Infinite Resistance Tube Checker—Build This Direct-Reading V-T Voltmeter—How to Make a Modern V-T Voltmeter—Measuring High Values of A.C. Voltage and Current With a Low-Range Meter—How to Make a Meter-Range Extender—How to Build a Practical Tube Tester and Set Analyzer—Antenna—The Beginners' Simple Volt-Milliammeter—Build This Simplified Neon-Type Test Unit—Midcut Oscilloscope—How to Make and Use a Frequency Wobbler—Double Tracing Your Oscilloscope—Home-Made Frequency Modulator.

**No. 26—Modern Battery Radio Sets**  
Outline of Contents: Beginner's 1-Tube High-Gain All-Wave Receiver—Beginners-Build This 1-Tube Loop Receiver—A "3-in-1" Battery Portable—An Easily-Built "Flowling Superregenerative" 2-in-1 "Card 116" Battery Set—A 2-Tube Superhet. With Pentagrid Heterodyne 2nd-Detector—The 4-Tube Superhet. Vacation Portable—The "Lunchbox 5" Battery Portable—The Seafarer's Loop-Type Boat Radio Set—4-Tube Permeability Portable—An All-Purpose Portable—A Typical Commercial 3-Way Portable (Pilot Models X-1452 and X-1453)—Switch for Varying "C" Bias on Battery Radio Sets—Making a Simple Portable Aerial—Making a Pilot-Light Fuse—Old Auto Sets for New Cars—Using a Loop Portable in Cars—Quasi-Electric Soldering Iron—Lamp Bulbs as Resistors.

**No. 27—Modern Radio Servicing Technique**  
Outline of Contents: Elementary Servicing Technique—Correct Procedure for the Servicing Beginner—Elementary Procedure for Servicing Radio Sets—A.F.C. Alignment Made Easy—Dynamic Servicing—Dynamic Testing Simplifies Servicing—Modern Receiver Test Requirements—Servicing Universal A.C.-D.C. Receivers—Servicing "Orphans" and Private-Brand Sets—Emergency Servicing Without Test Meters—Servicing Coils—Servicing R.F. Coils—Servicing Oscillator Coils—General Information—RMA Transformer Color Code—What Causes Echo, Fading?—Radio Service Puzzlers.

**No. 28—All About Frequency Modulation**  
Outline of Contents: The ABC of F.M.—Frequency vs. Amplitude Modulation—Basic Facts About F.M. Broadcasting—Construction—Build This Practical F.M. Adapter—Audio Amplification—F.M. Audio Amplifier, Part 1—F.M. Amplifier, Part 2—F.M. Audio Amplifier, Part 3—F.M. Service—Part 1. Antenna Installation and Service—Part 2. Receiver Alignment and Diagnosis—Part 3. Test Equipment for F.M. Servicing, Engineering—Part 1. The How and Why of F.M.—Part 2. The How and Why of F.M.—Theory and Design Considerations of R.F. and I.F. Coils in F.M. Receivers.

**SPECIAL SEND-NO-MONEY OFFER**

It is not necessary that you send money with order. If you wish to take advantage of our C. O. D. plan, simply cut out the coupon. Paste it on a post card and send it to us. Books will be sent to you immediately.

All four books are listed uniformly at 50¢ each. No discount on less than three books. If you wish to take advantage of our special offer, ordering three books or more, we make an unusual low price to you as follows:

3 books—\$1.25    4 books—\$1.50

Do not fail to send coupon today!

**RADIO-CRAFT PUBLICATIONS, INC.**  
25 West Broadway, New York 7, N. Y.

**RADIO-CRAFT PUBLICATIONS, INC.** 444  
25 West Broadway,  
New York 7, N. Y.

Get them—  
Rush to me by return mail, as per your special offer, the following books: (Check books selected.)

No. 25     No. 26     No. 27     No. 28

I will pay postman \$1.00 (if two books are ordered), \$1.25 for three books, \$1.50 for four books, plus a few cents postage and charges.

**WE CANNOT SEND A SINGLE 50¢ BOOK C.O.D.**

NAME ..... PLEASE PRINT CLEARLY

ADDRESS .....

CITY ..... STATE .....

Save shipping and C.O.D. charges! Check here if you send cash with order. (Cash, U.S. new postage stamps, money order, check.) Foreign countries no C.O.D. Add 20% to all prices quoted.

## Short-Cut Mathematics

COMBINED WITH  
*Practical Mechanics Simplified*

NEW 2-in-1 reading course! Now you can learn the speedy, simplified system of calculation used by draftsmen, engineers, accountants, "master minds" on the stage. Learn easy way to multiply 4 figures by 4 figures without using old-fashioned multiplication; add long columns of figures this lightning short-cut method. Learn horsepower, slide rule, micrometer, logarithms, wood measure, puzzles, etc., etc. Large illustrated volume complete with answers, only \$1 postpaid. Satisfaction or refund. Amaze your friends with your magic-like mental powers.

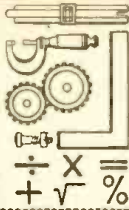

**FREE** Complete details... mail coupon TODAY!

NELSON CO., 321 So. Wabash, Dept. D-310, Chicago

Please send free details about "Short-Cut Mathematics and Practical Mechanics Simplified." No obligation.

Name \_\_\_\_\_  
Address \_\_\_\_\_

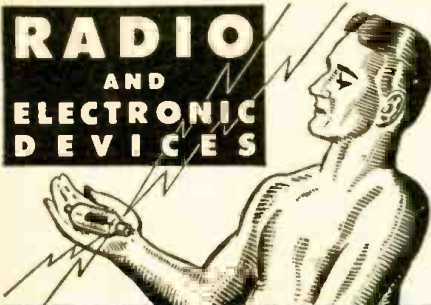

**RADIO AND ELECTRONIC DEVICES**

**BURSTEIN-APPLEBEE CO.**  
1012-14 McGee St. Kansas City, Mo.

**CANNON-BALL**  
is a good Headset guaranteed to satisfy you. For sensitivity, clarity of tone, dependable performance, use a Cannon-Ball Headset. Folder R-4 illustrates complete line. Write

Scientifically Built Heavy ear magnets greatly increase their efficiency.

**C. F. CANNON COMPANY**  
SPRINGWATER, N. Y.  
*Headset Headquarters*

**FADA**

**FACTORY SERVICE DEPT.**  
OFFERS you a completely equipped service organization to handle your repairs on Fada and all other make radios

**FADA OF NEW YORK**  
928 Broadway, New York, N. Y.  
Tel.: GRamercy 7-0951-2 and 0980

LARGE STOCK OF REPLACEMENTS AND CABINETS ALWAYS ON HAND

**PATENTS—TRADE MARKS**  
Booklet concerning Inventions & Patents Form "Evidence of Conception" with instructions for use and "Schedule of Government and Attorneys Fees"—Free

**LANCASTER, ALLWINE & ROMMEL**  
Registered Patent Attorneys

426 Bowen Bldg. Washington, D. C.

**BUY WAR BONDS**

## ELECTRONIC DIAGRAMS

(Continued from page 408)

matics which show tubes also show the commercial type number of the tube, or have a symbol designation numeral drawn near the tube symbol.

In many cases, the values of resistors and capacitors are indicated by lettering adjacent to the component symbol. For example, a 200 ohm resistor may be designated as  $\sim\sim\sim 200 \Omega$ , or  $\sim\sim\sim 200$  ohms. A capacitor as  $\sim\sim\sim -11-$  250 mid.

Vacuum tubes often have their commercial classification numerals near the symbol. A tube designated 6J5 would, of course, be a standard 6J5 tube. It is obvious that a competent technician must be able to readily distinguish commercial classification numbers from symbol designation numbers.

Tube sockets, if shown, are clearly marked with numerals to indicate the proper prong holes for certain connections. These markings are in accord with generally accepted practice as standardized by tube manufacturers in their catalogues. Reference to a catalogue to determine what particular connection a given socket number is, will serve to double check the schematic indication of wiring.

Jacks and switches are normally shown in the position in which they are at rest. Should a phone jack be shown with contacts closed, that would indicate the position of the jack's contacts in the open position,

before a plug is inserted in the circuit.

Switches are usually shown in their open position, or, in the case of a multiple position switch, with the switch arm thrown to the right or left, and occasionally to a center contact. This, however, is not an infallible rule and should never be presumed. Study the circuit characteristics and determine exactly what contact positions are indicated by a given switch position.

Tube sockets are rarely drawn on a schematic. The usual procedure is to indicate the existence of a socket for a particular tube by showing the usual schematic symbol for the tube and placing the designation, such as V-101, X-101, beside it, where V-101 is the tube and X-101 the socket for that tube. The socket designation is usually placed under that of the tube.

The reference groups V-101 and X-101 are known as symbol designations. Symbol designations are used to facilitate the compilation of parts lists and to simplify textual reference to a drawing. Such designations consist of reference letters with numerals affixed to them.

Reference letters, while not as standardized as graphical symbols, usually conform to the listings in Table 2.

The method of using these alphabetical symbols, as well as examples on actual schematics, will be covered in the next article, which will also deal with electrical industrial and wiremen's symbols.

### Alphabetical Portion of Symbol Designations.

Table 2

Designation letter	Classification
A.	Structural parts, panels, frames, braces, etc.
B.	Motors and Prime movers.
C.	Capacitors of all types.
D.	Dynamotors.
E.	Miscellaneous electrical parts; insulators, dials, etc.
F.	Fuses.
G.	Generators, exciters, etc.
H.	Hardware; screws, bolts, pins, snaps, etc.
I.	Indicating devices (except meters); pilot lamps, etc.
J.	Jacks and receptacles (stationary).
K.	Contactors, relays, circuit breakers, etc.
L.	Inductors (radio-frequency and audio-frequency).
M.	Meters of all types. Gages, thermometers, etc.
N.	Nameplates, charts, etc.
O.	Mechanical parts; bearings, shafts, couplings, etc.
P.	Plugs.
Q.	Diaphragms; microphone, telephone, projector, etc.
R.	Resistors, fixed and variable.
S.	Switches, Interlocks, thermostats.
T.	Transformers; radio-frequency, audio-frequency and power.
U.	Hydraulic parts.
V.	Vacuum and gaseous discharge tubes.
W.	Wires, inter-connecting cables without plugs.
X.	Sockets.
Y.	Mechanical oscillators, crystals, etc.
Z.	Impedances such as wave traps, etc.



# WORLD-WIDE STATION LIST

(Continued from page 415)

# FM LOCATION FOR DX

An audience of 5,000,000 people for one FM broadcast station is sought by Radio KPRO of Riverside, California. The station management plans to erect a high-powered transmitter on the top of Cucamonga Peak, near San Bernardino.

From this point, 9,000 feet above sea level, the station should cover an area of more than 48,000 square miles. Thus residents of southern California, western Arizona and southern Nevada would all be served by one FM broadcaster.

There is only one other projected transmitting site in the country which has potentially greater coverage. That is WMIT's proposed position on Clingman's Peak in North Carolina. It is expected to cover practically 70,000 square miles.

Mc.	Call	Location and Schedule	Mc.	Call	Location and Schedule
9.690	GRX	LONDON, ENGLAND	10.285	ZNR	ADEN, ARABIA
9.69	LRAI	BUENOS AIRES, ARGENTINA; Fri-days only, 5 to 5:30 pm; "Radio Del Estado."	10.345	—	BERN, SWITZERLAND; heard at 4 pm.
9.693	JIE2	TAIHOKU, FORMOSA; 8:30 to 10 am	10.300	—	"STATION DEBUNK"; Station of the All Free.
9.700	FIQA	TANANARIVE, MADAGASCAR; noon to 1 pm.	10.445	—	MOSCOW, U S S R; 7:40 to 8:00 am; 8:30 to 11 pm.
9.700	WRUW	BOSTON, MASS.; Caribbean beam, 6:15 to 7:15 pm; European beam, 2:45 to 5:55 pm.	10.48	—	HAVANA, CUBA; evenings.
9.700	WRUS	BOSTON, MASS.; Mexican beam, 7:30 pm to 2 am; North African beam, 6 to 7:30 am.	10.543	DZD	BERLIN, GERMANY; 5:50 pm to midnight.
9.705	—	FORT DE FRANCE, MARTINIQUE; 5 to 8:30 pm.	10.620	KES3	SAN FRANCISCO, CALIFORNIA; 1 to 6 am, Oriental beam.
9.715	OAX4K	LIMA, PERU; 7 to 9 pm.	10.75	—	RIO DE JANEIRO, BRAZIL; carries PRL8 program.
9.720	XGOA	CHUNGKING, CHINA; 8 to 11 am.	10.840	KWV	SAN FRANCISCO, CALIF.; Australian beam, 2 to 4:45 am; South American beam, 5 to 7 am.
9.720	—	"RADIO PATRIE"; also known as "Radio Resistance"; 3 to 3:12 pm.			
9.720	PRL7	RIO DE JANEIRO, BRAZIL; "Radio Nacional"; 4:10 to 5:50 pm.			
9.724	CSW	LISBON, PORTUGAL; African beam, 3 to 6:30 pm.			
9.730	CE970	VALPARAISO, CHILE; 7 to 11 pm.			
9.735	CXA15	MONTEVIDEO, URUGUAY; evenings.			
9.740	CSW7	LISBON, PORTUGAL; North American beam, 9 to 10 pm.			
9.750	—	ROME, ITALY; day and night transmissions.			
9.750	WKJ	NEW YORK CITY; North African beam, 5:15 to 7 am; 3:30 to 8 pm.			
9.755	—	"RADIO INCONNU"; 3 to 3:11/2 pm; chimes or bells.			
9.760	—	"DEUTSCHER KURZWELLENSENDER ATLANTIC"; 1:30 to 2 pm Sunday; 3:30 to 3:58 pm; 4:30 to 4:58 pm.			
9.765	OTC	LEOPOLDVILLE, BELGIAN CONGO; after midnight; used by "Radio National Belge."			
9.780	—	FRENCH EQUATORIAL AFRICA; 10:30 to 11 pm; irregular.			
9.780	—	ITALIAN UNDERCOVER STATION; 4 to 4:11 pm.			
9.785	OTC	LEOPOLDVILLE, BELGIAN CONGO; 5:45 to 6:35 pm; 8:15 to 8:45 pm; other times.			
9.825	GRH	LONDON, ENGLAND; 1 to 4:30 am; 11:30 am to 12:45 pm.			
9.830	GRX	LONDON, ENGLAND			
9.833	COCM	HAVANA, CUBA; 10 am to 11 pm.			
9.833	XPRA	KUNMING, CHINA; 8 to 9 am.			
9.835	—	"HUNGARIAN NATIONS RADIO"; speaks German; Sundays, 2:15 to 2:28 am; 9:15 to 9:27 am; 2:15 to 2:27 pm; 3:15 to 3:27 pm; 7:15 to 7:27 pm.			
9.845	—	"RADIO NAZIONALE FASCISTI"; 3:30 to 5:57 pm; 6 to 6:55 pm.			
9.860	EAQ	MADRID, SPAIN; 1 to 3 pm; 6:40 to 7:13 pm; 7:20 to 8 pm.			
9.865	—	MOSCOW, U S S R; 7 to 8 am; 10:40 am; 7 to 7:25 pm; 8 to 8:45 pm.			
9.870	—	"PRAHEVA"; 5 to 5:07/2 pm; opens with train whistle and closes with three train whistles; 7 language.			
9.880	CR7BE	LOURENCO MARQUES, MOZAMBIQUE; 6 to 8 am; 3 to 5 pm.			
9.880	—	MOSCOW, U S S R; 11 am to noon.			
9.895	—	"BULGARIAN FREEDOM STATION"; 2:15 to 2:28 pm; 3:15 to 3:30 pm.			
9.897	WKRD	NEW YORK CITY; European beam, 5 to 6:45 am.			
9.897	KROJ	LOS ANGELES, CALIF.; N.E.L.; Orient beam, 10:15 pm to 3:45 am; 11:15 am to 2:15; Australian beam, 4 to 9 am.			
9.897	WKRX	NEW YORK CITY; North European beam, 6 to 8:45 pm.			
9.935	—	"RADIO MEDITERRANEAN"; heard Sundays, 1:58 to 2:30 pm; as late as 11:20 pm.			
9.958	HCJ8	QUITO, ECUADOR; 9 to 9:45 am; as late as 11:20 pm.			
10.000	WWV	BELTSVILLE, MARYLAND; U. S. Bureau of Standards.			
10.005	—	VOICE OF FREE ARABS; Sundays, 2:15 to 2:34 pm; 3:15 to 3:35 pm.			
10.010	—	"BULGARIAN FREEDOM STATION"; 2:15 to 2:28 pm.			
10.050	XBHX	MEXICO CITY, MEXICO; 8 am to 8 pm daily.			
10.065	MTCY	MANCHUKUO; 1:30 to 3 am.			
10.105	HH3W	PORT AU PRINCE, HAITI; evenings.			
10.130	HH3W	PORT AU PRINCE, HAITI; 1 to 5 pm; 7 to 11 pm.			
10.22	PSH	RIO DE JANEIRO, BRAZIL; 7 to 8:15 pm; 8:30 to 9 pm.			
10.260	XGAP	PEIPING, CHINA; under Japanese operation; 9 to 11 am.			

## RADIO-ELECTRONIC REFERENCE-ANNUAL

Are you asking yourself: "What's next in Radio and Electronics?" What mysterious inventions are brewing in radio research laboratories? What effect will these wartime secret inventions have on peacetime conditions? Will the scientists take me into new, unfamiliar fields, requiring special technical education?

**Keep Posted With Radio-Craft**

Radio is once again at the crossroads! All must become students again of a science that has experienced a marvelous rebirth through ELECTRONICS. The question about the near and distant future now racing through your mind will be answered step by step in the forthcoming issues of RADIO-CRAFT.

**You Need This Free Reference Annual, Too!**

You can't plan intelligently ahead—you can't grasp the new—until you have thoroughly mastered the tried and accepted present-day radio developments. And that is where the REFERENCE ANNUAL comes to your aid. This fact-packed book is THE radio man's digest—it's the RADIO-ELECTRONIC WORLD OF TODAY and the COMING POST-WAR WORLD.

And think of it—you can get it absolutely free and postpaid by subscribing to RADIO-CRAFT now—but you must act quickly as war-paper shortage compels us to limit the printing. If you are already a subscriber we can extend your subscription.

**CUT OUT AND MAIL**

**RADIO-CRAFT**  
25 West Broadway  
New York 7, N. Y.

Be sure to use coupon or mention Free Reference Annual when ordering.

Gentlemen:

I want to take advantage of your Special Time Limit Offer for your RADIO-ELECTRONIC REFERENCE ANNUAL—1943-1944, which you will send me ABSOLUTELY FREE and PREPAID in connection with my subscription to RADIO-CRAFT and Popular Electronics for the period checked below.

I enclose my remittance of \$ \_\_\_\_\_

1 Yr. \$2.50     2 Yrs. \$4.50     3 Yrs. \$6.00

This is a new order     Renewal     Extension

Name \_\_\_\_\_ Please print clearly

Address \_\_\_\_\_

City \_\_\_\_\_ State \_\_\_\_\_

Postal Dist. No. (if any) \_\_\_\_\_

(Canadian and Foreign subscriptions 5c extra per copy. Send by International Money Order.)

**PARTIAL CONTENTS**

**RADIO-ELECTRONIC REFERENCE ANNUAL**

**ELECTRONIC THEORY AND GENERAL PRACTICE**

Is thoroughly covered in this book in easy-to-grasp language. Among the articles on this subject are: What You Should Know About Electronics—Electronic Tubes for Servicemen—The Electronic Solovox, Its theory and action—and The Photographic Phonograph Pickup, the principles underlying its operation.

**ELECTRONIC DEVICES YOU CAN BUILD**

Among the interesting and easily constructed devices selected are the following: Compact Hearing Aid—Oscillator—Automatic Key and Code Machine—Electronic Relays, Capacity and Light Operated High Frequency Radiotherapy, a complete home apparatus—and many other timely types of electronic apparatus.

**RADIO CONSTRUCTION**

Many well-illustrated, how-to-do-it articles, such as: Photo Oscillators, several types, adapted to playing records through your radio with a simple record player—T.R.F. Sets—Superheterodynes—Power packs for portable Receivers, making it possible to use your battery portable on the electric light line—A two-tube Super Midret Amplifier, which is a palm-of-the-hand public address system—and many others.

**SOUND AND RECORDING**

Including detailed instructions on constructing: High-Fidelity Amplifier—Exponential Horn with perfect reproduction down to 50 cycles—Electronic Expander—Compressor—Ain tone circuit—Semi-Pro Recording—Electronic Bass and Treble Expanding Circuits—Equalizers, etc.

**TEST INSTRUMENTS**

A complete line including: A Tube Checker with universal hookup; can check any tube regardless of the group to which its elements are brought out—Component Multimeter; 18 ranges of accuracy on an 11-point, 2-range switch—A Three Tube Signal Tracer, capable of checking R.F., A.F. and audio circuits—A Condenser Analyzer which measures both capacity and checks leakage—and an Electron-Ray Voltmeter which dispenses with hard-to-set milliammeters, using a GES tube instead.

**SERVICING**

Articles on servicing supply a multitude of methods and useful ideas, including: Dynamic Testing with Signal Generator—Modernizing a Test Set—Calibrated UHF Oscillator and countless other hints for ironing out kinks in your servicing problems.

**TIME LIMIT OFFER**

**RADIO-CRAFT WITH FREE COPY RADIO-REFERENCE ANNUAL**

**1 Year \$2.50**  
**2 Years \$4.50**  
**3 Years \$6.00**

If you are already a subscriber we can extend your subscription if you will check "Extension" box.

**SOME ENGINEERS  
WE DON'T WANT  
AT NATIONAL UNION**



Let's make it plain. There are a lot of engineers **WE DON'T WANT**. We have an outstanding group of engineering specialists who are **GOING PLACES**. They're thinkers, doers, practical dreamers. We're proud of them. **WE DO WANT** more engineers to join them but they have to be fellows who measure up. If you're not just trying to hit a high spot today. If you want to get into the exciting war work we're doing now and ride along on our great peace time electronic tube band wagon—**THIS IS YOUR BIG OPPORTUNITY**. We are adding to our staff engineers who specialize in

**ELECTRONIC TUBES  
PRODUCTION  
DEVELOPMENT  
MEASUREMENTS  
PHYSICS  
ELECTRICITY  
TRANSMITTING TUBES**

Our laboratories in Newark, N. J., offer ideal working conditions. We prefer that you have a degree in electrical engineering, physics, chemistry or mathematics—your experience, however, may be sufficient.

Why don't you find out whether you're one of the engineers National Union **DOES WANT**. Write and tell us about yourself or Phone **HUMboldt 2-5252, Ext. 72**, for appointment.



**NATIONAL UNION RADIO  
CORPORATION**

**50 Spring Street, Newark, 2, N. J.**



## **ELECTRICAL TESTERS**

**MEN AND WOMEN**

for radio transmitters  
and receivers and  
similar equipment

Young men and women who have been licensed radio amateurs preferred, or those having a good technical knowledge of voice communication and trained in electrical testing of radio equipment, are needed for inspectors and testers.

## **WESTERN ELECTRIC CO.**

**IN PEACE**

Source of supply for the Bell System

**IN WAR**

Arsenal of communications equipment

*Write, or apply in person to:*

**C.R.L., Dept. 4816  
100 CENTRAL AVE.  
KEARNY, N. J.**

Mon. through Sat. 8:30 a.m.—5 p.m.

Release statement & U.S.E.S. consent  
needed.

### **ELECTRONS SCORE AGAIN**

Electronic heating has scored another triumph—this time doing a welding job entirely impossible by ordinary technique:

Present methods for manufacturing hollow propeller blades for airplanes require a copper or copper-alloy fillet in the leading and trailing edges to alleviate sharp corners in these regions. Welding on the outside edge is not sufficient to hold the two pieces together and it is, of course, impossible to weld along the inside edge. With induction brazing, beads of brazing material are laid along the inner edge. The propeller is then moved edgewise through the output coil of an oscillator and the beads are fused—this securely binds the edges together. This work has been done with a torch but it takes much longer. It requires greater skill and results in greater warpage of the blades.

**Bendix-Marine**  
PRECISION EQUIPMENT

## **AN OPPORTUNITY FOR**

- **ELECTRONIC ENGINEERS**
- **ELECTRONIC DESIGNERS**
- **ELECTRICAL ENGINEERS**
- **ELECTRICAL DESIGNERS**
- **PHYSICISTS**
- **DESIGN DRAFTSMEN**

to take an active part in the war effort and PEACE-TIME developments in the Marine and Industrial Field.

These are permanent positions and offer unlimited opportunity to men with ability, vision and desire to work among congenial people.

**WRITE NOW**—stating background, experience, salary requirements—in full confidence to

**PERSONNEL DEPARTMENT**  
Release and U.S.E.S. Consent Needed.

## **MARINE DIVISION**

**BENDIX AVIATION CORP.**

One Hanson Place • Brooklyn 17, N. Y.

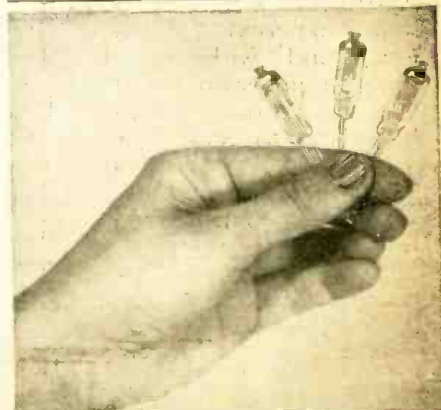

These minute tubes are the type used in the new Zenith low-priced hearing aid. Rated at 0.625 volts, two of them can be hooked up in series from a single flashlight cell. Current requirements for voltage amplifiers is only 25 Ma., for power amplifiers, 50 Ma. Power output runs to 7.5 milliwatts, though the 3 milliwatt tube is used in many hearing aids.

*This Fast-Growing Company Needs—*  
**ELECTRONIC TECHNICIANS**

- ★ DEVELOPMENT ENGINEERS
- ★ INSPECTION ENGINEERS
- ★ PHYSICIST
- ★ ELECTRONIC EQUIPMENT TECHNICIANS
- ★ MECHANICAL DRAFTSMEN
- ★ AND OTHERS

A real opportunity for experienced men, particularly with well-balanced backgrounds in acoustics, broadcasting, frequency modulation, ultra high frequencies and special device circuits. Openings exist in designing, development and manufacturing of cathode ray, transmitting and general-purpose tubes; communications, electronic and precision test equipment. Excellent post-war possibilities.

In replying give age, draft status, technical education, training and experience; salary requirements, availability. Enclose photograph. Write direct to:

*President*

**NORTH AMERICAN PHILIPS COMPANY, INC.**

Dobbs Ferry, Westchester County, N. Y.

*If working in essential industry at highest skill, please do not reply.*

**OPENING for  
MOTOR  
ENGINEER**

Engineer with electric motor experience, ingenious, and with sound basic engineering knowledge, to be assigned unhampered to very interesting project. Location East. Medium sized concern with established reputation in electronics field. Salary commensurate with ability.

BOX 404  
c/o RADIO-CRAFT Magazine  
25 West Broadway, New York 7, N. Y.

**ENGINEER  
COMMUNICATION  
EQUIPMENT**

To design electronic devices, transformers, filters, etc.—mostly Audio frequency. Working knowledge of trigonometry and LC circuits necessary. Also some experience on communications equipment or mechanical manufacturing. Salary open. Draft exempt or deferable by reason of education or experience. Excellent post-war prospects. USES referral card will be required.

**Audio Development Co.**

2833 13th Ave. So.  
MINNEAPOLIS, MINN.

**RADIO WRITERS**

Resident in the New York Metropolitan area. For part or full-time work on established radio magazine. Capable of writing articles on assigned radio or electronic subjects, expand or digest technical data, press releases, etc., or to carry on research work under editorial direction. Apply

Box 47, Radio-Craft  
25 West Broadway, New York 7, N. Y.

Arrest of the chief engineer of a company manufacturing precision equipment for war use brings to light the fact that a few misguided individuals are sporadically attempting to use the ether for their own amusement. The FCC announced the arrest of Frederick A. Turner, who was operating a home-built set in his Brooklyn apartment.

He was of course immediately picked up by the monitoring apparatus of the FCC, which has increased to many times its pre-war efficiency due to the necessity of hunting down transmitters which might be in touch with the enemy.

A few amateurs failed to heed the Government's warning to get off the air after December 7, 1941, and were picked up at that time. Most of them were let off with permanent revocation of their licenses.

This kid-glove policy has been dropped, and it is understood that the Government will press for full penalties. Operation of such stations is dangerous in that it diverts monitoring services from more important work, and should it become general, would interfere with war radio activities.

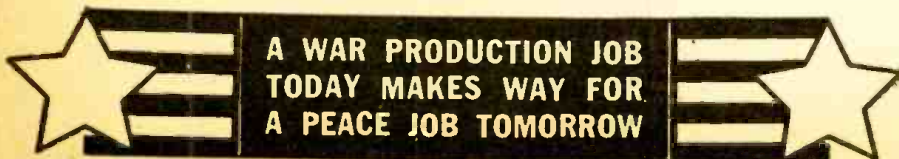

# INSPECTION ENGINEERS

for quality control work  
MEN OR WOMEN

to do inspection and testing of radio and other high-frequency equipment

Background required: knowledge of D.C., A.C. and electronic theory. High school with some college background in Physics and Mathematics or radio school essential. Experience in amateur radio with license desirable but not required.

## WESTERN ELECTRIC CO.

IN PEACE

Source of supply for the Bell System  
IN WAR

Arsenal of communications equipment

Write, or apply in person to:

C.R.L., Employment Dept.  
100 CENTRAL AVE.  
KEARNY, N. J.

Mon. through Sat. 8:30 a.m.—5 p.m.  
Release statement & U.S.E.S. consent  
needed.

# MOTOR ENGINEER

Position open for engineer who desires full opportunity to develop own ideas on very interesting new project. Necessary qualifications: originality, sound knowledge of fundamentals, and experience in electronic motor design. Salary open.

**Raytheon Mfg. Company**  
Personnel Department,  
Waltham, Mass.

## ELECTRON AGE COMING

(Continued from page 404)

be made without acid or hand manipulation.

Mrs. America will be able to shop hours longer and still get home in time to "fix" dinner. Present day experiments, using intense heat generated by high frequency or short-wave radio, have radio-cooked some foods in as little as 3 seconds time . . . and all indications point to new and hitherto unsuspected possibilities for cooking with radio power.

New methods and tubes may permit radio transmission, not only of sound, but of

phonic sound, transmitted over two separate radio channels from two microphones some distance apart in the studio, and received through two separate speakers in the home.

Television will be received in colors and in three dimensions, on an 18- by 24-inch screen in the home, or on the regular motion picture screen in theaters.

Electronic clocks with no moving parts will tick off the seconds, minutes and hours with flashing electric lights.

General Electric's photoelectric spectrophotometer, which distinguishes two million colors, and draws a curve showing the exact characteristics of each. The time required to give the exact curve for a color is less than five minutes, whereas older visual methods of recording a color required hours.



power. Already as much as one horsepower has been sent through the air. This is only the beginning. Someday, perhaps a bridge will be built or a building demolished—with power supplied by radio.

Radio crystals (whose electric properties were first discovered in 1880 by the Curies) have amazing uses, and many potentialities. They can keep radio stations on assigned channels, serve as microphones, earphones and loud-speakers, keep time, measure the most minute roughness of finished machine parts, analyze human heartbeats, create and detect inaudible sounds, help paint television pictures, talk and listen.

According to a little booklet, "Industrial Science Looks Ahead," issued recently by the Radio Corporation of America, we may expect the following:

Fluorescent wall paints, which become luminous in various designs when activated by invisible ultra-violet rays.

Electronic devices to open your car doors by push-button; also an electronic collision-preventer. A car television set with one screen visible to the driver, which will cut off automatically while the car is in motion—and a second screen visible to back-seat occupants at all times.

Television "eyes" and electronic apparatus capable of guiding airplanes to earth through any kind of weather.

Radio-telephone communication to and from ships at sea from dial telephones; two-way television communication with ships.

Books recorded on sound-film to be heard rather than read.

In radio communication, RCA sees even greater advances; high-speed radio telegraph routes handling 650 words per minute, pocket radios which may resemble a cigarette case or lady's compact; radio programs with two-dimensional or stere-

Newspapers will be transmitted directly into the home, and will be printed there by radio facsimile equipment attached to the home television receiver.

Safety at sea and in the air, already helped by automatic collision preventers, absolute altimeters and detecting and ranging devices, will be further increased by automatic, unattended radio weather stations and beacons throughout the world.

With such a beginning, even the most fantastic possibilities loom as probable future actualities. When you hear someone exclaim, "Will wonders never cease!", you can rest assured they have only begun . . .

In fact, a new, extensive crop of radio wonders to come are in process of development at this very moment—test tube wonders of Today which will become the accepted realities of Tomorrow.

FCC's new chief engineer in charge of broadcasting is George P. Adair, who was promoted to that post last month by unanimous action of the Federal Communications Commission.

Mr. Adair fills the position vacated by former Chief Engineer E. K. Jett, who now becomes a member of the FCC. Lt. Jett has been FCC chief engineer since 1938.

Mr. Adair is a Texan, and prior to joining the FCC technical staff worked for a number of years with the Radio Engineering Department of General Electric at Schenectady. During his period with the Commission he has specialized in studies of broadcast allocation, and was instrumental in drawing up the Commission's Standards of Good Engineering Practice.

The post of assistant chief engineer in charge of broadcasting is now filled by Philip E. Siling, former chief of the International Division.

# TECHNOTES

## ZENITH 6G60FM 3-WAY PORTABLE

Complaint: Although it operates on battery, the set goes dead on A.C. after playing about five minutes.

The cause is usually a leaky 20 mfd. section of the 40-20 mfd., 150-volts dual electrolytic condenser which is connected to the center tap of the filament dropping resistor.

T. HORIUCHI,  
Rock Springs, Wyoming

## RCA VICTOR C-11-1, D-11-2

Trouble: Weak and intermediate reception. The former was due to a dead oscillator tube (6J7). The latter was more difficult to find as the set would go off and was difficult to get back.

Trouble was traced to a wire rubbing inside the I.F. amplifier coil can. This can was located just behind the 6J7 oscillator tube. It has been my experience that this wire is too close to the shield can in this model. With the least provocation the wire will touch the shield and cut off reception.

CECIL LEE BRIGGS,  
Denton, Texas

## GENERAL ELECTRIC LF-116

This set is noted for blowing .02 mfd., 400 V. condensers. These condensers are marked as C14, C31, C32 and C40 in the schematic diagram of this set. These should be replaced with 600-volt ones to eliminate any further trouble.

WILLIAM PORTER,  
Los Angeles, Calif.

## SILVERTONE 101.583

Often the speaker field and transformer will heat up when the set is on about one-half hour. The trouble is occasioned by a leaky by-pass condenser, leading to the tube 6AC5G cathode and plate.

HAROLD WURM,  
Appleton, Wisconsin

## SILVERTONE 132-803

A common trouble is that the set is dead and yet will show a high voltage on the cathode of the 12K7GT. The trouble is in the 100-ohm resistor R12 from cathode to common ground.

WILLIAM PORTER,  
Los Angeles, Calif.

## PHILCO MODEL 610 AND 37-610

Complaints of weak, with intermittent reception, in these receivers is often due to leaky trimmer condensers, caused by dampness. Dismantling and cleaning all trimmer condensers in the oscillator and pre-selector sections and realigning brings them back to normal.

(NO NAME),  
Natural Bridge, N. Y.

## PHILCO MODEL 630-635

Loud whistle while tuning with volume control at a low setting.

This was found to be due to the grid lead to the 75 detector tube. Putting this lead inside the tube shield cleared up the trouble.

WM. KREICHBAUM,  
Lebanon, Penna.

## GENERAL ELECTRIC GD-60

In most cases where the complaint about this model is intermittent operation, I have found the trouble to be due to resin on the push-button contacts.

Remove with alcohol, or if caught in a home, scrape off with a pen-knife.

DAVID LINKER,  
Brooklyn, N. Y.

## PHILCO MODEL 816

Very low volume. All voltages, etc., check perfect.

Look for a high-resistance leak between center lug on volume control and ground. Clean control and set will operate normally.

T. G. CHAMBLESS,  
Fresno, Calif.

## GRUNOW 12A

Scratchy noises with slight distortion. Sounds like bad I.F. transformers, and the serviceman is likely to investigate these first.

Trouble will be found in a leaky coupling condenser. Replace both.

T. G. CHAMBLESS,  
Fresno, Calif.

## LOUD-SPEAKER REPAIRS

Mimeotype correction fluid is very handy in the repair of voice coils and cones of speakers. The fluid comes in handy small bottles with applicator brushes. It dries very rapidly and is elastic enough when dry to vibrate with the speaker cone and not crack.

SGT. T. C. HOLLMAN,  
Danville, Ky.

## GENERAL ELECTRIC L-660

A common fault in this set is a gradual increase of hum with increase of volume control. This is due to the electrolyte in the filter block liquidizing when the condenser breaks down and flowing into the 6SK7 (1st I.F. tube) socket. This is not noticed at times and even after replacement of the condenser the fault is apparent because of the leakage created by the electrolyte between the filament and control grid.

The remedy is to replace the socket.

LEO STROLLO,  
Brooklyn, N. Y.

## CROSS-MODULATION HUM?

I find that in many of the older sets, tunable hum is experienced.

In many cases this can be done away with by connecting a small condenser—not larger than .01 mfd.—from each plate of the rectifier to the rectifier tube filament. This is well worth trying when you are bothered with hum experienced when a station is properly tuned in.

HAROLD W. BROMFIELD,  
Wilkes-Barre, Penna.

(Editor's Note—Since a breakdown of one of these condensers would have serious consequences, condenser quality and voltage ratings must be carefully considered. Note that the condenser connected to the non-conducting plate during any half-cycle has the voltage of the whole secondary (less the small drop between the conducting plate and filament) across it. Therefore the rating should be roughly 1.5 times the voltage of the whole secondary. For a transformer rated at 300-300 each side of center tap, a 1,000-volt [preferably mica] condenser would be indicated.)

USED  
Correspondence  
Courses

NELSON CO., 321 So. Wabash Ave., Dept. 210, Chicago, Ill.

## MASCOT SLIDE RULE

Fits the pocket. Quickly solves any problem in multiplication, division, proportion. Gives the square, the square root, logarithm and reciprocals of all numbers. Trig scales give sines and tangents of numbers. Fine black graduations on white celluloid. Price in fabricoid case \$1.00. In leather case \$1.25. Money back if not satisfied. Special offer to agents and dealers.



MONITOR SLIDE RULE  
6" Dia. Made in white Vinylite. Same scales as Mascot Slide Rule. Without case \$2.95. Leatherette case 75c additional.

TAVELLA SALES CO., 25-WD W. Broadway, N.Y. 7, N.Y.

## Complete Plans

For Building Useful and Practical Things at Home. Each issue of Popular Homecraft is crammed with plans for making such beautiful and useful things as: Furniture, Bird Houses, Lamps, Outdoor Garden Furniture, Candle Environments, etc. Covers lathe work, tools, wood-working, leathercraft, copper. You'll find 'how-to' make almost everything from the pages of Popular Homecraft. Scores of drawings and photographs make every step simple as A, B, C. A real "How-To-Do-It" magazine.



Six Months' Trial \$1.00

Send \$1.00 today for trial six months' subscription. Money Back if Not Delighted.

## POPULAR HOMECRAFT

937 Palmolive Building Chicago, Ill.

## Trial 6 Months \$1.00

300 WAYS  
TO MAKE  
MONEY



68

PAGES

25c  
Per Copy

SOLD ON A  
MONEY-BACK  
GUARANTEE!

MAIL ORDER PLANS  
TESTED MONEY MAKERS  
BUSINESS SECRETS  
SUCCESS SCHEMES

BRAND  
NEW BOOK  
40,000 WORDS  
IN TEXT!

In "CASH IN" you get ALL the real money-makers—dozens of profitable tested mail order plans, confidential business secrets, dozens of practical tested formulas, successful tested schemes—actual experiences of men who have started on a shoestring—with less than \$10 capital.

Buyers of This Book Tell Us—  
"Biggest value I've yet to see. Book is worth at least a dollar." S. Buda, B'klyn, N. Y.  
"Your book is as good if not better than others selling at \$1.00."

George Brunet, Montreal, Can.  
"CASH IN" is the best value I have yet to see in the mail order field."

Lawrence Fox, Brooklyn, N. Y.  
"CASH IN" contains only tested ideas covering every type of full- or spare-time enterprise—it's a "masterpiece" in business ventures.  
25c a copy postpaid. Send U. S. stamps or coin.

NATIONAL PLANS INSTITUTE

P.O. Box 26R, Station N  
New York 23, N. Y.

## MORE FM APPLICATIONS

SEVENTY-SEVEN applications for FM stations were before the FCC early last month, indicating that the interest in post-war FM is being maintained and increasing.

The majority of applications are from owners of AM stations now in operation. Others are from individuals and organizations not at present in the field. Seventeen are from newspapers, six from networks, and there is one from an advertising agency, two from labor organizations and one from a university.



# "THE INDUCTANCE AUTHORITY"

By EDWARD M. SHIEPE, B.S., M.E.E.

THE ONLY BOOK OF ITS KIND IN THE WORLD, "The Inductance Authority" entirely dispenses with any and all computation for the construction of solenoid coils for tuning with variable or fixed condensers of any capacity, covering from ultra frequencies to the borderline of audio frequencies. All one has to do is to read the charts. Accuracy to 1 per cent may be attained. It is the first time that any system dispensing with calculations and correction factors has been presented.

There are thirty-eight charts, of which thirty-six cover the numbers of turns and inductive results for the various wire sizes used in commercial practice (Nos. 14 to 32), as well as the different types of covering (single silk, cotton-double silk, double cotton and enamel) and diameters of  $\frac{3}{4}$ ,  $\frac{7}{8}$ , 1,  $1\frac{1}{8}$ ,  $1\frac{1}{4}$ ,  $1\frac{3}{8}$ ,  $1\frac{1}{2}$ ,  $1\frac{3}{4}$ , 2,  $2\frac{1}{4}$ ,  $2\frac{3}{4}$ , 2", and 3 inches.

Each turns chart for a given wire has a separate curve for each of the thirteen form diameters.

The book contains all the necessary information to give the final word on coil construction to service men engaged in replacement work, home experimenters, short-wave enthusiasts, amateurs, engineers, teachers, students, etc.

There are ten pages of textual discussion by Mr. Shiepe, graduate of the Massachusetts Institute of Technology and of the Polytechnic Institute of Brooklyn, in which the considerations for accuracy in attaining inductive values are set forth.

The book has a flexible fiber cover, the page size is 9 x 12 inches and the legibility of all curves (black lines on white field) is excellent.

Order from your dealer or direct—\$2.50

## GOLD SHIELD PRODUCTS

350 Greenwich St. (Dept. R.C. 4), New York City

## NEW! ALLIED'S Rapid R-F RESONANCE & COIL WINDING CALCULATOR

only 25c



Simple! Easy to use! For fast accurate determination of resonance factors and coil winding data. Only 25c postpaid. No. 37-955.

ALLIED RADIO CORP.  
833 W. Jackson, Dept. C2-D-4, Chicago 7

## ALLIED RADIO

## Inventions Wanted Patented or Unpatented

We have been successfully selling inventions, patented and unpatented, since 1924. Write us, if you have a practical, useful idea for sale.

CHARTERED INSTITUTE OF AMERICAN INVENTORS  
Dept. 111, 631 Pa. Ave., N.W., Washington, D.C.

## ZENITH EXPANDS EAST

The Zenith Radionics Corporation of New York, a subsidiary of Zenith Radio Corporation, will handle the electronic activities of the Zenith organization. The new organization, founding of which was announced last month, will market the Zenith Hearing Aid and other Zenith devices. Establishment of this new subsidiary is an indication of the importance of electronic business in the post-war program.

# The Mail Bag

## STIFF COMPETITION AHEAD

Dear Editor:

When this present great conflict is successfully terminated, thousands of skilled and semi-skilled radiomen (and women) will be released from the armed forces. Possessing a superb theoretical background and being intimately acquainted with radio circuits of today and electronic circuits of tomorrow, they will soon make a place for themselves in the radio world. Many will undoubtedly find their way into the radio service field.

With the production of new receivers again being resumed, the emphasis will shift from service to sales. Radios which are currently in use will be discarded, not repaired. Such service business as exists will

go to those who are best informed technically, with some natural preference for ex-servicemen. Competition will be intense. "Screw driver mechanics" and tinkers who are now cashing in on the present war boom will fall by the wayside.

To be fore-warned is to be fore-armed. The present day radio serviceman who contemplates remaining in business after the war, must remember the only way to do so is to increase the size of your customer file, provide *real* service, keep abreast of new developments, and acquire a greater store of technical knowledge.

Yours truly,

PAUL BAUMAN,  
St. Cloud, Minn.

## RADIO'S GREATEST NUISANCE

Dear Editor:

Many years I have watched with repressed fury the plight of the radio Serviceman as he is "chiseled" by most wholesalers who sell tubes to the public at the same price as to Servicemen, plus free tube check.

The three national watch companies will not sell watches or parts to any store who does not employ a full time watchmaker, and just let them hear of a sale at less than

their list price and that store is "quits" for at least the next 99 years.

If tube manufacturers are the Servicemen's friend they claim to be, they would do well to keep down braggarts from saying they bought a "PDQ" tube from your own wholesaler for 51 cents less than you ask for the same piece of merchandise.

J. S. BROWN,  
Trion, Ga.

## THE MAIL BAG OR WIND BAG?

Dear Editor:

Have been reading your very good magazine for the past several years, being a subscriber during this time, and have enjoyed many of the articles on service work, and also I get a kick out of the many arguments, both pro and con, in the mail-bag. It sometimes seems as if it should be called the *Department of Windbags*.

I own and operate a shop, now the only one in a town of about fifteen hundred people. I have a large trading area in the surrounding country and also some of the neighboring towns, as the radio servicemen have all gone to help Uncle Sam. All of my help have answered the call, so it leaves my wife and me to handle the business. She keeps the books and helps around the

shop during her spare time to wait on customers, answer the telephone, and does most of the ordering (and do we have plenty of that nowadays) and keeps up the necessary correspondence. I take care of the service work and heavy work that is incidental around a shop such as we have here. And work is something of which we have plenty right now. I have been almost consistently running about sixty to seventy sets behind, besides all of the small electrical appliances that also come in for repair. With the shortage of tubes and parts, the biggest thing that I am short on, is time to do the work.

DONALD HAGERMAN,  
Belle Plaine, Minn.

## PARTS PROBLEM NO OBSTACLE

Dear Editor:

In the June issue of *Radio-Craft* you printed a diagram of "A Midget Oscillator for Code Practice" by David Gnessin.

This was just what I was looking for. After much trouble I was able to get hold of the parts. I then proceeded to build it and found that it worked very nicely. I believe many young fellows like myself have done the same thing.

I am a new comer and did not have any junk box parts to use. I talked to a local serviceman to see if he had any old sets the owners had decided weren't worth repairing, but many people were repairing them instead of throwing them away. Only after quite a struggle was I able to get the parts.

I have noticed lately that you have printed quite a lot of one tube receivers. But couldn't you print a receiver using most of the parts in the Midget Oscillator so we could listen to code signals and thereby gain additional practice?

I believe many newcomers would be interested in this plan because after you build a code practice set you want to build a one tube set to gain practice.

DONALD BUNCH,  
Aberdeen, Washington

(Here is an example to some of our "experimenters" who feel that it is impossible to work if the radio supply house cannot furnish a component with the exact part number specified in an article.—Editor)

## INTERESTING ANALOGIES

Dear Editor:

Enjoy your magazine the best of all radio magazines. Yours at least gives the beginner a chance to get started while some of the rest take it for granted that everyone is a ham or engineer and knows it all. What I know about radio I owe to the U. S. Army and the information taken from your informative articles.

I am an instructor in Radio Theory at the Field Artillery School of Fort Sill, Okla. To all my students who ask for further reference than their text books (which are quite brief and to the point due to the short time for instruction) I refer them to your magazine. I like your simple analogies explaining the more intricate studies of radio. Some of them are amusing but very instructive and useful in my line. A good analogy of some electrical function will save many moments of technical explanation. I've found them very useful. Keep up the good work.

SGT. GERALD E. WALLICK,  
Lawton, Okla.

## AIR-COOLED SERVICEMAN

Dear Editor:

In reply to the letter of J. W. Fleurdelys and the record of 60 sets in two hours, I was wondering if he got his wires crossed and intended his letter to go to the Liar's Club up in Wisconsin. We've been having a south wind here in Nebraska and I thought that I smelled smoke. I certainly wish that I could work that fast, although I should think that there would be danger of the cabinets catching on fire. Even a Superadioman couldn't repair radio sets that fast. What does he mean by "about 60"? Does he mean any number from one to 60 sets? No wonder the Navy grabbed this "one man assembly line." At this rate a serviceman could make about \$200,000 a year if he could keep up the pace. (Less, of course, the cost of parts.)

JOHNNY SNYDER,  
Omaha, Nebraska

Dear Editor:

The writer chanced to read the article "Keep 'Em Playing" in *Radio-Craft* of July, 1943, by Mr. M. J. Edwards, and I want to express my thanks for information so clear and to the point. I would like to read and hear more of the writer.

PAUL DARIS,  
Brooklyn, N. Y.

## REFERENCE ANNUAL JUST OFF THE PRESS!

The 1944 RADIO-ELECTRONIC REFERENCE ANNUAL is now available for those thousands of RADIO-CRAFT subscribers who are entitled to it because they took advantage of our Pre-Publication offer. It has finally been printed and is now being mailed to these subscribers.

This comprehensive reference work was delayed in completion due to conditions beyond our control, such as wartime labor and paper shortages. We wish to thank all those entitled to a copy for the extreme patience shown during the waiting period.

We feel that the book was well worth waiting for because in the long run you will benefit by the months of effort which the editors put into research and compilation. It is the sort of book you will refer to again and again throughout the year.

# ORDER YOUR COPY TODAY

*Limited Supply Available*

Volume 2 of the OFFICIAL REFRIGERATION MANUAL, which was published in 1935, contains service data and information of value to everyone interested in refrigeration.

There has been a tremendous demand for this manual, especially during the last year. This has been due to the discontinuance of new models for the duration of the present emergency and the necessity of servicing all old refrigerators and keeping them in service as long as possible.

You will find this Manual very helpful in repairing refrigerators and keeping them in good working order until new refrigerators can again be manufactured.

**OVER 350 PAGES  
OVER 300 DIAGRAMS**

To order this Refrigeration Manual—

**MAIL COUPON  
TODAY FOR YOUR  
COPY**

**RADCRAFT PUBLICATIONS, INC.**  
25 West Broadway, New York 7, N. Y.

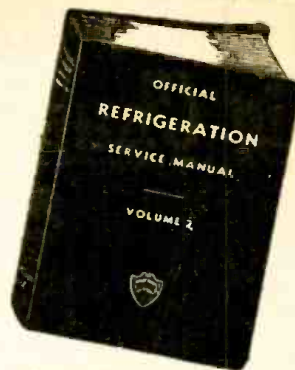

### Partial Contents

Theory and Fundamental Laws  
Methods of Refrigeration  
Refrigerants, Lubricants and Brines  
Handling and Storage of Refrigerants  
Compression System of Refrigeration  
Liquid Throttle Devices Refrigeration Systems  
Electric Control Devices  
Compressors, Types, Seals, Valves, Capacities  
Evaporators and Cooling Units Service Tools  
Commercial Unit Specifications  
Servicing Refrigeration Apparatus  
Servicing Low Side Float Valve Systems  
Servicing High Side Float Valve Systems  
Servicing Expansion Valve Systems  
Servicing Thermostatic Valve Systems  
Servicing Restrictor and Capillary Tube Systems  
Charging Systems with Refrigerant  
Electrical Service: Motors, Fuses, Hookups  
Estimating Refrigeration Loads

RADCRAFT PUBLICATIONS, INC. RC-4-44  
25 West Broadway, New York 7, N. Y.

Gentlemen:—Enclosed you will find my remittance of \$5.00, for which please send me one copy of the OFFICIAL REFRIGERATION SERVICE MANUAL (Volume II). I understand that this book is to be shipped to me POSTAGE PREPAID.

Name .....

Please Print Clearly

Address .....

City ..... State .....

## ELECTRONIC CIRCUIT CHECKS (Continued from page 411)

possible to correct intermittent receivers and waste practically no time doing so. Before we see why, let us look into signal tracing and check its technique.

As stated before, the signal tracer is nothing more than a universal output meter, with which we can check an R.F. or A.F. signal. Obviously, to check R.F., the meter must be an R.F. voltmeter, while for A.F. it must be an A.F. voltmeter. Without explaining why, let us state that the meter cannot be an ordinary A.C. meter; we must have a selective instrument which will indicate only A.F. when required or only R.F. of a certain frequency.

The circuits used in different manufactured models to produce a signal tracer vary. As they are the same basically, let us describe a fictitious instrument.

Suppose we have an all-wave three-stage tunable amplifier as shown in Figure 1a and rectify its output so that we may use an electron ray tube to indicate the intensity of any signal applied to its input, the amplifier being tuned to the frequency of the signal. Since we have incorporated an indicator, this device becomes an R.F. output meter, and will respond only to an R.F. signal to whose frequency it is tuned. The input is provided with a test prod. which is special only in that it includes a small isolating capacity at its tip, as shown, to minimize loading of the circuit to which it is connected. We see now that the input probe can be connected to any point in any circuit where R.F. exists and not only the existence of a signal but its fre-

quency and gain may be determined. (A gain control is always included so that we may vary the sensitivity of the R.F. channel and prevent the "eye" from closing on all signals above a certain level.) In most cases the gain control knob is calibrated so that we may determine the relative gain; using the indication of the "eye" just closing as reference.

In like manner, we incorporate an A.F. output meter, and this may consist of a two-stage audio frequency amplifier. Note again, that a blocking condenser is used right at the probe tip.

Most signal tracers also include a so-called "oscillator channel," which does not provide any signal of its own, as its name might seem to indicate. It is really another R.F. channel and is called the "oscillator channel" only because it is designed, primarily, to check the oscillator stage. In this case we can use a single stage of tuned radio frequency amplification, because the local oscillator of a superhet generates a strong radio frequency signal, which is more than sufficient to actuate an electron ray tube with a relatively small amount of amplification. Actually, this channel can, and is, used anywhere in a receiver where the R.F. signal is strong enough to give an indication on the electron ray "eye."

Thus far we have two R.F. channels and one A.F. channel, and it is now only necessary to add a sensitive D.C. voltmeter, so we can check D.C. voltages

(Continued on following page)

# NOW'S Your Big Chance!



## TURN YOUR EQUIPMENT INTO CASH—AT HIGHEST PRICES

Right now is when you can do your government a favor, and do yourself a favor at the same time! Communications equipment is needed . . . and I'll pay the highest cash price for that equipment you're not using. The government will get what they need, and you'll get cash—or trade-in credit—to buy the post-war super-equipment.

**YOU'LL BE SET FOR NEW, BETTER RIGS WHEN THE WAR ENDS**



## I WANT HALLICRAFTERS

I'm especially interested in any Halli-crafter equipment you have, but will pay top prices for transmitters, receivers and parts of any make. Write today and tell me what you have. I'll quote you cash price by return mail.

# Free!

## GIANT WALL-SIZE RADIO REFERENCE MAP

Here's a gift from me that you'll surely want. I've printed a brand new reference map, with time zones, amateur zones, all standard broadcast stations, shortwave stations, systems four major networks—lots more information. Easily worth two dollars or more, but it's yours free! Send 15 cents to cover packing and mailing.

## LEO-W9GFQ

Wholesale Radio Laboratories  
744 W. BROADWAY, COUNCIL BLUFFS, IOWA

## OPPORTUNITY AD-LETS

Advertisements in this section cost 20 cents a word for each insertion. Name, address and initials must be included at the above rate. Cash should accompany all classified advertisements unless placed by an accredited advertising agency. No advertisement for less than ten words accepted. Ten percent discount six issues, twenty percent for twelve issues. Objectionable or misleading advertisements not accepted. Advertisements for May, 1944, issue must reach us not later than March 28th, 1944.

Radio-Craft • 25 W. B'way • New York 7, N. Y.

**CORRESPONDENCE COURSE TEXTS. WHILE THEY LAST.** Cathode Ray Tubes, Vacuum Tube Oscillators, Tank Circuits, Alternating Current, Inductive Reactance, Capacitive Reactance, D.C. Meters, D.C. Power, Transformers, Vacuum Tubes, 35 cents each, any three for \$1 PP. Set of 10 for \$3.00, with book on Light, Radiation and Luminescence Free. Written as though the instructor was talking to you, and profusely illustrated. Electronic Text-book Co., 221 Wilson Ave., Wollaston 70, Mass.

**USED CORRESPONDENCE COURSES AND TECHNICAL BOOKS BOUGHT, SOLD, RENTED, CATALOG FREE.** Educational Exchange, Henagar, Alabama.

**PREPARE NOW FOR TREMENDOUS OPPORTUNITIES** in new fields of radio after the war. Training for Federal Licenses. Write for particulars. American Radio Institute, 41 East 23rd Street, New York 10, N. Y.

(Continued from previous page)

without undue loading of certain circuits such as the a.v.c. circuits.

## THE ELECTRONIC VOLTMETER

Figure 2a shows the schematic of the electronic voltmeter used in most signal tracers, while Figure 1d shows it as the D.C. channel of the signal tracer. By designing the circuit of Figure 2a so that the pointer normally indicates ½ full scale deflection of the meter, we can obtain indication of both positive and negative voltages without reversing leads. The electronic voltmeter shown is nothing more than a Class "A" amplifier using any low-mu triode and provided with degeneration, since the by-pass condenser across the bias resistance is omitted. Adjustment of the meter to half scale is accomplished by selecting the proper value of  $R_2$  and by the zero adjustor  $R_1$ , which in effect, varies the voltage to the plate of the tube.

If a positive voltage is applied between the grid and ground, the cathode current increases, the meter reads upscale and is directly proportional to the applied voltage, since we operate the tube on the linear portion of its characteristic curve. If the applied voltage is negative with respect to ground, the grid repels electrons, decreasing the cathode current, and hence the meter reads down scale. Figure 2b gives an idea of the meter scale used. Tapping the grid leak by means of a tap switch permits us to include several voltmeter ranges.

The electronic voltmeter presents an extreme advantage over the 1000 ohms per voltmeter and is even much superior to the 20,000 ohms per voltmeter, since it draws practically no current from the circuit across which it is connected. This advantage becomes apparent when servicing "intermittent" receivers, where even the slightest loading may be sufficient to "operate" a receiver which was being tested while inoperative. This is annoying to a serviceman who is baffled when a dead receiver suddenly begins to operate nicely simply because he connected a voltmeter which draws current across a "touchy" circuit. Note the use of the one megohm isolating resistance in the tip of the test prod. Since the electronic voltmeter draws no current there is no voltage drop or loss across the resistor.

The electronic voltmeter is also useful in checking oscillators or measuring low voltages across high resistances.

Now that we have available a signal tracer, let us proceed to see just how we make use of it. Let us remember that in the instrument described, which is typical, we have 4 channels available and for best efficiency we should use as many channels as possible at one time.

## SIGNAL TRACING APPLIED

Figure 3 shows the complete schematic diagram of a typical six-tube broadcast receiver. Let us apply the technique of signal tracing to it. In the following example it should be noted how we proceed to reduce the "sphere of fault" until finally only one part can be suspected. Also note that as many of the channels as possible are used.

In the first example we shall take a simple case and tell you which part is defective so that steps may be understood as well as followed. Let us assume that this receiver is dead and the trouble is due to an open in the plate load resistance of the 1st A.F. stage,  $R_1$ .

We should proceed as follows: First, with the set and test instruments thoroughly warmed up, pull the 42 power tube from

(Continued on page 448)

## Index to advertisers

Allied Radio Corp.	432, 444
Amperite	433
Audel & Company	Back cover
Audio Development Co.	441
Bendix Aviation Corp.	440
Brown's Radio Center	435
Burstein-Applebee	438
Cannon Company, C. F.	438
Chartered Institute of American Inventors	444
Chicago Novelty Co., Inc.	425
DeForest's Training, Inc.	427
Echophone	391
Fada of New York	433
General Electric Co.	426
Gold Shield Products	444
Hallcrafters, Inc.	387, 393
Harrison Radio	425
Henry Radio	431
Hudson Specialties	434, 436
Lancaster, Allwine & Rommel	438
Meissner Manufacturing Co.	392
National Plans Institute	443
National Radio Institute	385
National Schools	429
National Union Radio Corporation	Inside front cover, 440
Nelson Company	438, 443
North American Philips Co.	441
Onan & Sons, D. W.	433
Ohmite Mfg. Co.	430
Opportunity Adlets	446
Popular Homecraft	443

## RADIO SCHOOL DIRECTORY

Page 448

Candler System  
Capitol Radio Engineering Institute  
Commercial Radio Institute  
Lincoln Engineering School  
New York Y.M.C.A.  
RCA Institutes  
Tri-State College

Radcraft Publications, Inc.  
421, 437, 439, 445

Radio & Technical Division of Murray Hill Books, Inc.	417
Raytheon Mfg. Co.	442
Sprague Products Co.	390
Sprayberry Academy of Radio	389
Supreme Publications, Inside back cover	
Sylvania Electric Co.	428
Tavella Sales	443
Technifax	435
University Laboratories	435
Western Electric Co.	440, 442
Wholesale Radio Laboratories	446

(While every precaution is taken to insure accuracy, we cannot guarantee against the possibility of an occasional change or omission in the preparation of this index.)



# BOOK REVIEWS

**PRACTICAL RADIO AND ELECTRONICS COURSE**, for home study. Prepared under the direction of M. N. Beitman. Published by Supreme Publications. In three volumes: *Fundamentals of Radio and Electronics, Receivers, Transmitters, and Test Equipment; Applied Electronics and Radio Servicing.* Heavy paper covers, 8½ x 11 inches, 368 pages. Price \$3.95.

The practical approach of some of the author's earlier works is followed in this complete course. No previous electrical, radio or mechanical knowledge on the part of the student is pre-supposed, and the first lesson is devoted to telling him how to get a knob off a radio receiver and take the chassis out of the cabinet (for examination only).

Once confronted with his receiver, the beginning student is informed as to the names of controls formerly known to him only as knobs on the front of the panel. In the next lesson he is shown the necessary tools used in radio and electronic work and gets some light on the mechanical angles of radio construction. Lesson Three is devoted to (simple) radio mathematics, and he is then ready to begin actual radio theory in Lesson Four, "Circuits using Resistors."

Alternating current is taken up in the next chapter, and the student follows the orthodox course through A.C. theory to vacuum tubes, function of receiver components, audio and radio frequency amplification. Treatment of a number of these subjects is broad, microphones and pickups being handled under *Audio Amplifiers and Accessories*, and vibrator-type power packs under *Power Supplies*. Photographs of actual apparatus appear throughout.

The second volume supplements the work of the first on receiver equipment, dealing however with the receiver as a complete unit, then goes on to transmitters and servicing apparatus. Volume Three is largely devoted to descriptions of electronic apparatus, from communications receivers to the absolute altimeter.

One feature of the book is unique. Each page is divided into two columns. Text matter is in the wider one, and in the narrower, bold-face type is used to point up the important facts, give hints or warnings, suggestions, or carry additional information. The column may have only one short note on a full page, or as many as half-a-dozen. The effect is to give the student some of the benefit he would receive from the advice and admonitions of a personal instructor. This should be a valuable feature in home study.

No table of contents appears in any of the three volumes, but each is carefully indexed by subject.

**HOW TO PASS A WRITTEN EXAMINATION**, by Harry C. McKown. Published by McGraw Hill Book Co. Stiff cloth covers, 6 x 8½ inches, 162 pages. Price \$1.50.

More than one student has discovered that a knowledge of the technique of taking examinations is as important as knowing his subject. Many individuals have fallen far short of the standings to which their

grasp of the subject-matter should entitle them. Lack of information as the methods of handling the particular type of examination, overlooking points whereby credits may be made and an underappreciation of the technique of examinations often are the cause of their downfall.

The author divides preparation into three classes—emotional, physical and mental, and gives a chapter to each, followed by another of general suggestion on taking examinations.

Two chapters then instruct the student in answering the old-type, or essay, examination, and the new-type, objective question tests. Advantages and disadvantages of both are tabulated, and the reader is left to estimate the relative worth of the two systems.

Many of our younger college students with a dozen years' unbroken experience in taking tests will no doubt feel that they could give the author a few pointers on his own subject. The war-time student who may be twenty years out of school, the trainee with no idea of new-type examinations, and that large group of largely self-trained persons whose war-time courses bring them up against such examinations for the first time in their lives, will find the book useful.

**SCIENCE AT WAR**, by George W. Gray. Published by Harper and Brothers. Stiff cloth covers, 6 x 8½ inches, 296 pages. Price \$3.00.

All branches of science have had their part in the prosecution of this war, and the spur of war has likewise forced them all forward to the extent of two or three decades' ordinary peacetime progress. Electronics easily takes first place among the sciences in its decisive effect on military technique, and has probably advanced further in the past two years than any other.

It is therefore not surprising to find that the author has come upon electronic devices in every field covered. He points out that a shell may meet no less than five pieces of electronic apparatus in the various steps from molten steel to finished product. These vary from phototubes for timing operations and electronic heaters for surface hardening to chronoscopes and X-rays for tests on the finished product.

Electronics also receives a fair share of attention in its own proper field. The story of how Radar won the Battle of Britain is told in detail. The use of FM, micro-wave communication, supersonics in submarine detection, electronic control circuits in ships and planes and the electronic gun director are credited with their share of the job of winning the war.

The important progress in communications is already partly known to the radio-man, but will be interesting to the lay reader.

A complete chapter is given to the War of Ideas, which with the rising importance of radio in comparison to other methods of propaganda is now almost completely electronic. The author deals technically with the methods used in implanting ideas in willing and unwilling listeners, his handling of the subject making this one of the most interesting chapters in the book.

**ELECTRON-OPTICS**, by Dr. Paul Hateschek. Translated by Arthur Palme. Published by the American Photographic Publishing Co. Stiff cloth covers, 6½ x 9½ inches, 161 pages. Price \$3.00.

Starting from the discovery, with the Geissler tube, that electricity would flow in a vacuum, the author proceeds to deal with that flow as a beam of electrons, and brings to our attention the fact that optical considerations exist in all electronic tubes. The fact had escaped many, even those very familiar with "beam" power amplifiers.

Several of the earlier chapters are devoted to the theory of light optics—by no means a waste of time, since the principles of light and electron optics are shown to be fundamentally the same. These principles are then applied to electromagnetic and later to electrostatic lenses, as used in the cathode-ray tube. The explanations and illustrations are remarkably clear, and the reader, even though he may have no knowledge of optics and little of electronics, has little difficulty in grasping the ideas presented.

The electron microscope is introduced in a chapter on resolving power and the limit of enlargement, and later handled in more detail. The Zworykin and Farnsworth systems of television are compared, and the Iconoscope explained in such a manner as to take some of the mystery out of television.

Leaving the obvious applications of electron optics, the author turns his attention to optical principles in amplifier tubes. Passing over certain deflection-type amplifiers, electron paths in standard tubes are discussed, and the lens effect of the grid-wires on these beams indicated.

Electron multipliers are treated as another application of electron optics, and some space is given to the original Slepian electron multiplier, with its magnetic lenses. Chapters are also given to light-and-voltage-controlled multipliers.

The last chapter is written by the translator, to bridge the gap between 1936—when the body of the book was written—and the present. Latest developments in the electron microscope, television, and multipliers are treated.

**COMMUNICATIONS CIRCUITS**, by Lawrence A. Ware and Henry R. Reed. Published by John Wiley and Sons. Stiff cloth covers, 6 x 8½ inches, 330 pages. Price \$3.50.

The second edition of this work has been revised to take into account the increasing importance of ultra-high frequencies in communications engineering. A complete new chapter, treating wave guides in detail, has been added. Selection of tube sizes, modes of transmission for specific purposes, field configuration, criteria for tube shapes, and methods of excitation and detection are covered in this chapter.

Two other chapters cover rectangular and cylindrical wave guides respectively. There is also a chapter on coaxial lines and one transmission-line experiments.

Other (earlier) chapters in the book  
(Continued on following page)

# Radio School Directory

TO OUR READERS—NOW IS THE TIME TO TAKE UP RADIO!

**N**OW, more than ever before America needs trained radio men. The Army, the Navy and the Air Force are continuously on the lookout for men who have had training in radio. Scores of war industries require radio men in various capacities throughout the country. There now is and there will be a great shortage of radio men for years to come. Reputable schools of Radio advertise to help you.



Send for this FREE 52 page Book.

It shows that "crack" operators rely on something besides practice to develop their high speeds and proficiency. It explains the "knack" of sound-sense and sound-consciousness—the secret of speedy sending and receiving. Once you acquire these mental processes, reading code becomes almost second nature to you. The Candler System, endorsed by telegraph champions, will train you quickly to be a High-Speed Radio Operator or Amateur. If you want s-p-e-e-d and proficiency—send for this revealing book now.

**CANDLER SYSTEM CO.**

Dept. 3D, Box 928, Denver, Colo., U.S.A.

And at 121 Kingsway, London, W. C. 2, England

## RADIO TECHNOLOGY



IRCA Institute offers an intensive two-year course of high standard embracing all phases of Radio and Television. Practical training with modern equipment. Also shorter specialized courses in Commercial Radio Operating, Radio and Television Servicing, and Aviation Communications. For Free Catalog write Dept. RC-41.

**IRCA INSTITUTES, Inc.**

A Radio Corporation of America Service  
75 VARICK STREET NEW YORK 13, N. Y.

## RADIO ENGINEERING!

DEGREE IN 27 MONTHS

**R**ADIO today offers great future for women as well as men. Demand for graduates exceeds supply. Courses also in Civil, Electrical, Mechanical, Chemical, Aeronautical Engineering; Business Administration, Accounting, Secretarial Science. Tuition, living costs low. 61st year. Cosmopolitan student body. Enter June, Sept., Jan., March. Catalog.

**TRI-STATE COLLEGE** 2444 College Ave. ANGOLA, INDIANA

### Pre-Induction RADIO COURSES

for Civilians and those entering Military Services. New classes now starting for men and women.

- RADIO OPERATING
- RADIO SERVICING
- CODE ELECTRONICS

New York Y.M.C.A. Schools  
4 W. 64th Street New York City

(Continued from previous page)

treat of network theory and practice, the infinite line, general lines, the power transmission line and wave filters.

This is strictly an engineering work, and a knowledge of calculus and alternating current theory on the part of the student is pre-supposed. The approach is more practical than in many similar books, especially in the chapters on networks, impedance matching and wave-guides. An interesting feature not often found in texts written on this level, and one the independent engineer will find most useful, is the inclusion of a number of problems at the end of each chapter.

## ... Here's How You Can Qualify for a BETTER RADIO JOB!

CREI technical training is preparing others for good-paying radio jobs—WHY NOT YOU?

Are you finding yourself in a routine job—a job that any other man can handle just as well as you? Today, radio JOBS are many—but radio CAREERS are few! Now is the opportune time for you to equip yourself with the necessary technical training to qualify for an important engineering position with a sound future.

NOW when industry needs men, is the time for you to investigate radio career training. Your radio experience backed by modern CREI technical training will equip you to share in the good-paying jobs that await trained men... and to make good in the important positions that lead to security and happiness!

**WRITE TODAY!** If you are a professional or amateur radio man and want to make more money—let us prove to you we have something you need to qualify for the better job opportunities that can be yours. To help us intelligently answer your inquiry—please state briefly your education, radio experience and present position.



## CAPITOL RADIO ENGINEERING INSTITUTE

Dept. RC-4, 3224 16th St., N.W., Washington 10, D.C.

## Correspondence Courses in RADIO and ELECTRICAL ENGINEERING

**ELECTRICAL ENGINEERING** Get good grasp of wide electrical field. Prepare yourself, at Low Cost, for secure future. Modern simplified, you can understand quickly.

**RADIO ENGINEERING** Extra fine course in radio, public relations, public address, photo-electric work. Trains you to be super-service man, real vacuum tube technician. Servicemen needed badly. Diploma on completion. Tuition \$25 either course. Deferred payment plan. Get copies of school catalogs, student magazines, complete details. SEND NOW!

**FREE**

LINCOLN ENGINEERING SCHOOL Franklin Stn., Box 61-C62 WASHINGTON, D. C. (Formerly at Lincoln, Nebr.)

## COMMERCIAL RADIO INSTITUTE

A radio training center for twenty-three years.

RESIDENT COURSES ONLY

Pre-Induction, Broadcast, Service, Aeronautical and Radio telegraphy classes now forming. Literature upon request.

Dept. C., 38 West Biddle St., Baltimore 1, Md.

## ELECTRONIC CIRCUIT CHECKS

(Continued from page 446)

its socket and listen for a click in the speaker, telling us that voltage is produced by the power supply.

Connect the Signal Tracer ground clip to the receiver chassis and feed a 1000 Kc. modulated signal from the Signal Generator to the antenna and ground terminals and tune the receiver to 1000 Kc.

Now connect No. 1 probe (R.F. channel) to point 2 on Figure 3, setting the dial to 456 Kc., the I.F. Connect No. 2 probe (A.F.

channel) to point 5 and the No. 3 probe (Osc. Channel) near the oscillator coil L3 (in most cases a direct connection is not necessary) and set to 1456 Kc. (1000 plus 456). The No. 4 probe (Electronic voltmeter) should be connected to point 4 and set to the 5-volt range. All gain controls should be on full.

A look at the electron ray tubes of channels 1, 2, and 3 and also the meter of channel 4 should tell us a few things:

1. The R.F. channel eye will close since a signal will appear at point 2.

2. The A.F. channel, however, will show no closing of the eye since the A.F. signal does not reach that far.

3. The oscillator channel will indicate a signal at 1456 Kc.

4. The Electronic Voltmeter should read a negative voltage of almost 5 volts, since a signal is applied to the diodes and rectified, causing a voltage across the diode load resistance, across which the meter is connected.

We know definitely then, that the signal is lost somewhere between the diode load resistance and the plate of the output tube, and that it is an audio circuit, therefore, we may only use channels 2 and 4.

We should now connect the No. 2 probe to the plate of the 1st A.F. tube, point 6, and having the electronic voltmeter available, we should connect it also to the same point. The results should indicate no A.F. signal at this point and in addition, that no D.C. plate voltage exists.

The rest may be accomplished by a voltmeter, although often it is necessary to narrow the "sphere of fault" to one single part. It should be appreciated that since we have the electronic voltmeter handy a quick check at point 7 will absolve C<sub>1</sub> of being shorted.

We might point out that other methods might have been applied in this case.

In this next example we will illustrate the technique used and very briefly describe our connections in tracking down a case of "intermittent reception."

We proceed as before, connecting the R.F. probe to point 2, the A.F. probe to point 5, the oscillator probe near the oscillator coil, L3, and the electronic voltmeter to point 4. When the receiver stops playing we note the results and find that a signal of 450 Kc. appears at point 2, and a signal of 1456 Kc. at the oscillator, indicating it is operating and at the correct frequency. However, the voltmeter and A.F. channel show no signal.

The trouble should lie between the plate of the mixer and the detector diode.

Rearranging and making maximum use of our channels, we connect the R.F. probe to point 3, the oscillator probe to point 8, the A.F. probe to point 4 and the voltmeter to point 3, also.

When the set again stops, it is found that none of the channels show a signal, although the D.C. voltage at point 3, is available and does not change.

Since we now know that the signal is lost between the plate of the mixer and plate of the I.F. tube, we may try a trick and remove the ground clip from the chassis and reconnect to B plus. Now use the R.F. probe at point 2. The oscillator probe may be connected to point 9, both being set to 456 Kc. Notice that we are checking to see if an R.F. voltage appears across each tuned circuit. This time when the set cuts off, it is found that no R.F. voltage appears at the grid of the I.F. tube, whereas the signal across the primary is intact. One more check across the secondary of IFT-1 itself, might be advisable before suspecting the I.F. transformer. In a real case, it was found that the transformer secondary opened intermittently.

# RADIO-ELECTRONICS

## HOME-STUDY COURSE

## AMAZING OFFER

IN 3 BIG MANUALS

8½ x 11 in.  
50 LARGE LESSONS  
New 1944 Edition



M. Beltman, teacher and author of many books, directed this preparation. Instructions to help you study at home included in the narrow column on each page.

ONLY  
**\$3.95**  
COMPLETE  
3 VOLUMES  
50 Lessons

New, 1944, radio-electronic course of 50 large fact-packed lessons; covers every topic of radio and modern electronics; bound in three big manuals and sold complete at the unbelievable bargain price of only \$3.95, nothing else to pay. Now is your chance to take advantage of this amazing money-saving offer. Let this home-study course guide you quickly to an essential high-pay interesting job in a radio plant, or in electronic War industry, or help you open your own radio service shop, or aid you in getting higher rank in the Army. Learn radio and electronics to earn more money now; prepare for the coming after-the-war opportunities in Electronics and Radio.

### THREE COURSES IN ONE

You will find this complete training of 50 large lessons is really three distinct courses covering (1) *Practical Radio*, (2) *Applied Electronics*, and (3) *Radio Servicing*. The lessons are clear, practical, interesting, easy to master and use. No special education or previous experience is needed. Notice in the illustration of the manuals (at the left) how the helpful explanations and remarks, in the narrow column on each page, serve as the teacher, stress the more important points, show you how to perform many self-teaching experiments using any home-radio. There are hundreds of review self-testing questions, 427 drawings, pictures, diagrams, and service hints. These newly prepared lessons will teach you all about basic radio, transmitters, test equipment, radio servicing, and every topic of modern Electronics — photo-cells, X-ray, metal locators, FM, airplane beacons, recording, facsimile, welding controls, television, etc.

### GREATEST BARGAIN IN RADIO-ELECTRONIC TRAINING

Get a complete course of training in practical radio and electronics for less than the cost of a single book. The fifty large lessons, making up the course in 3 volumes, are simple to follow, easy to master and apply. Many drawings, examples, diagrams, and instructor's suggestions (in the side column, on each page) help you move along quickly and find learning interesting fun. Review questions at the end of each lesson permit you to check your progress. You enjoy learning important radio and electronic facts. In a surprisingly short time, you are ready to do highly skilled radio repairing, building of electronic equipment, or hundreds of other War-winning tasks in the growing Electronic and Radio industries.

### MANY LESSONS ON RADIO REPAIRING

Volume 3, of the course, includes lessons, service hints, case histories, and trouble-shooting charts which will show you how to repair all radio sets quickly and easily. This material alone is worth many times the low price of \$3.95, for the complete 3-Volume course. Send no-risk order coupon today. Look over and use these lessons for 10-days without obligation. You have everything to gain—and nothing to lose.

**These lessons will tell you all about**

Meters, Microphones, Power Supplies, Test Equipment, Circuits, Oscillators, X-Ray, Amplifiers, Facsimile, Photo-cells, Superhets, Television, Recording, Alignment, Detectors, Motor Control, Radio Servicing, Electronics in Industry, Gages, Radio circuits, Hints, Testino radio parts, Transmitters, Metal Locators, Operating, Frequency standards, Analyzers, Welding Controls, Tube testers, P.A., High-frequency heating, Beacons, F.M. Tubes, and hundreds of other topics.

### Lessons on all Phases of Electronics and Practical Radio

Let this authoritative, easy-to-understand, practical course pave your way into Electronics—the money-making field of the future. Prepare now. Use this training in your spare time to get ahead in a good War-job. Be ready to grab the opportunities in post-war Electronic development. Let these lessons train you, serve as your teacher and guide, and give you the needed practical time-saving hints on the job. All topics completely indexed—all subjects easy to find. An educational value that cannot be duplicated at any time.

### LIMITED QUANTITY

All three volumes of the Practical Radio and Electronics Course have just been printed. Although a large quantity of courses is on hand now, our bargain price will create a tremendous demand. Government (WPB Order L-245) paper limitation policies may prevent reprinting. Better order immediately for examination—no obligation.

SEND TRIAL ORDER COUPON TODAY

### BE A RADIO-ELECTRONIC EXPERT

Train quickly, in your spare time and in your own home, for a well-paying interesting job in the expanding two-billion dollar radio-electronic industry. You begin with elementary principles and quickly progress to practical explanations of radio building, servicing, and all branches of Electronics. In these well written 50 lessons, experts from every field of electronics tell you important facts and knowledge which they gained during years of practical experience. These easy-to-follow, well illustrated lessons will give you the useful "know-how" needed to obtain and get ahead on the job. Send coupon today and examine all three volumes in your own home, without obligation.

### POST-WAR OPPORTUNITIES IN ELECTRONICS

New electronic applications, devices, and accomplishments, not even imagined a few years ago, are now helping us win the War. Remarkable and unique new civilian uses of electronics and radio will result immediately after the War. The peace-time advancement in the radio-electronic industry will compare with the rise of the auto industry after the last war. Plan and prepare to be in the midst of this opportunity. Let this lowest priced, home-study course give you the needed training.

\*\*\*\*\*  
**Money-Back Guarantee**  
 You must be entirely satisfied or your money will be immediately refunded. You are permitted to make full use of the course for 10 days, on a trial basis.  
 Supreme Publications  
 \*\*\*\*\*

### SENT ON TRIAL FOR 10 DAYS

Take advantage of our no-risk examination offer. Send trial order coupon. You will receive the complete 3-volume Course for 10 days use. Begin your radio-electronic study without cost or obligation. If you are pleased, the complete course of 50 lessons, in three large manuals, is yours to keep for only \$3.95, full price, otherwise it costs you nothing for the examination.

### NO RISK TRIAL ORDER COUPON

SUPREME PUBLICATIONS, 328 S. Jefferson St., Chicago 6, Illinois  
 Ship the complete 3-Volume Practical Radio and Electronics Course for 10 days examination.

- I am enclosing \$3.95, full price, send postpaid.
- Send C.O.D. I am enclosing \$..... deposit.

I must be satisfied or you will refund my money in full.

Name: .....

Address: .....

# Supreme Publications

PUBLISHERS OF RADIO BOOKS, MANUALS, AND DIAGRAMS

328 South Jefferson Street

Chicago, Illinois

# Audels RADIOMANS GUIDE

**1001 RADIO FACTS  
AND FIGURES**

**772 PAGES · 400 DIAGRAMS · CHARTS AND PHOTOS**

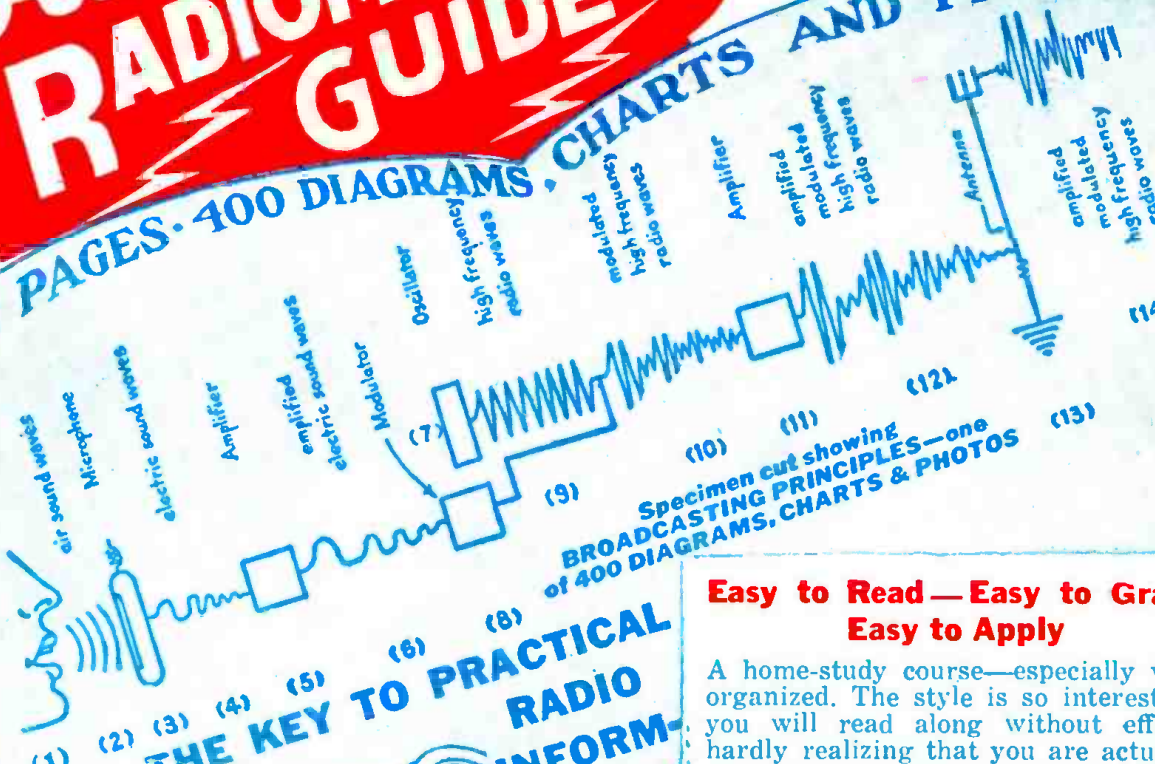

**THE KEY TO PRACTICAL  
RADIO  
INFORMATION**

It gives you in usable form pointers on radio, including frequency modulation, television, etc. Also valuable inside information for Aviators, Marines, Commercial Operators and Technicians, Servicemen and Students.



**Q AND A  
UNIQUE  
QUESTION  
and  
ANSWER  
METHOD**

**Highly Endorsed**

**A COMPLETE LIBRARY IN ONE BOOK**

AUDELS RADIOMANS GUIDE gives authentic Principles and Practices in Construction, Operation, Service and Repairs. Covers clearly and concisely radio fundamentals—Ohm's Law—Physics of sound as related to radio science—Measuring instruments—Power supply—Resistors—Inductors—Condensers—Transformers and examples—Broadcasting stations—Radio Telephony—Receivers—Diagrams—Construction—Control Systems—Loudspeakers—Antennas—AutoRadio—Phonograph Pick-ups—Public Address Systems—Aircraft and Marine Radio—Radio Compass—Beacons—Automatic Radio Alarm—Short Wave—Coil Calculations—Testing—Cathode Ray Oscillographs—Static Eliminations—Trouble Pointers—Underwriter's standards—Units and tables. REVIEW QUESTIONS—READY Reference Index.

**Easy to Read—Easy to Grasp  
Easy to Apply**

A home-study course—especially well organized. The style is so interesting you will read along without effort, hardly realizing that you are actually studying and taking in vital information. Audels Radiomans Guide gives you just the right amount of mathematics required to cope with radio problems successfully. You can solve, with the aid of this extraordinary book, practically every radio problem that comes up. At your finger tips is a complete index for instant use.



**7 DAYS' FREE TRIAL**

THEO. AUDEL & CO., Publishers  
49 West 23rd Street, 10, New York

**\$4**

COMPLETE

**PAY \$1 A MO.**

Mail AUDELS NEW RADIOMAN'S GUIDE for free examination. If O.K. I will send you \$1 in 7 days; then remit \$1 monthly until \$4 is paid. Otherwise I will return it.

Name \_\_\_\_\_  
Address \_\_\_\_\_  
Occupation \_\_\_\_\_  
Reference \_\_\_\_\_

**MAIL THIS  
COUPON  
TODAY**

RCF